

Splice Box Wiring Diagram

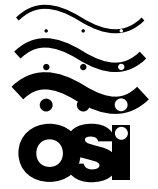

Oreco Systems[®]
Incorporated

814 AIRWAY AVENUE

SUTHERLIN, OREGON

97479-9012

TELEPHONE:



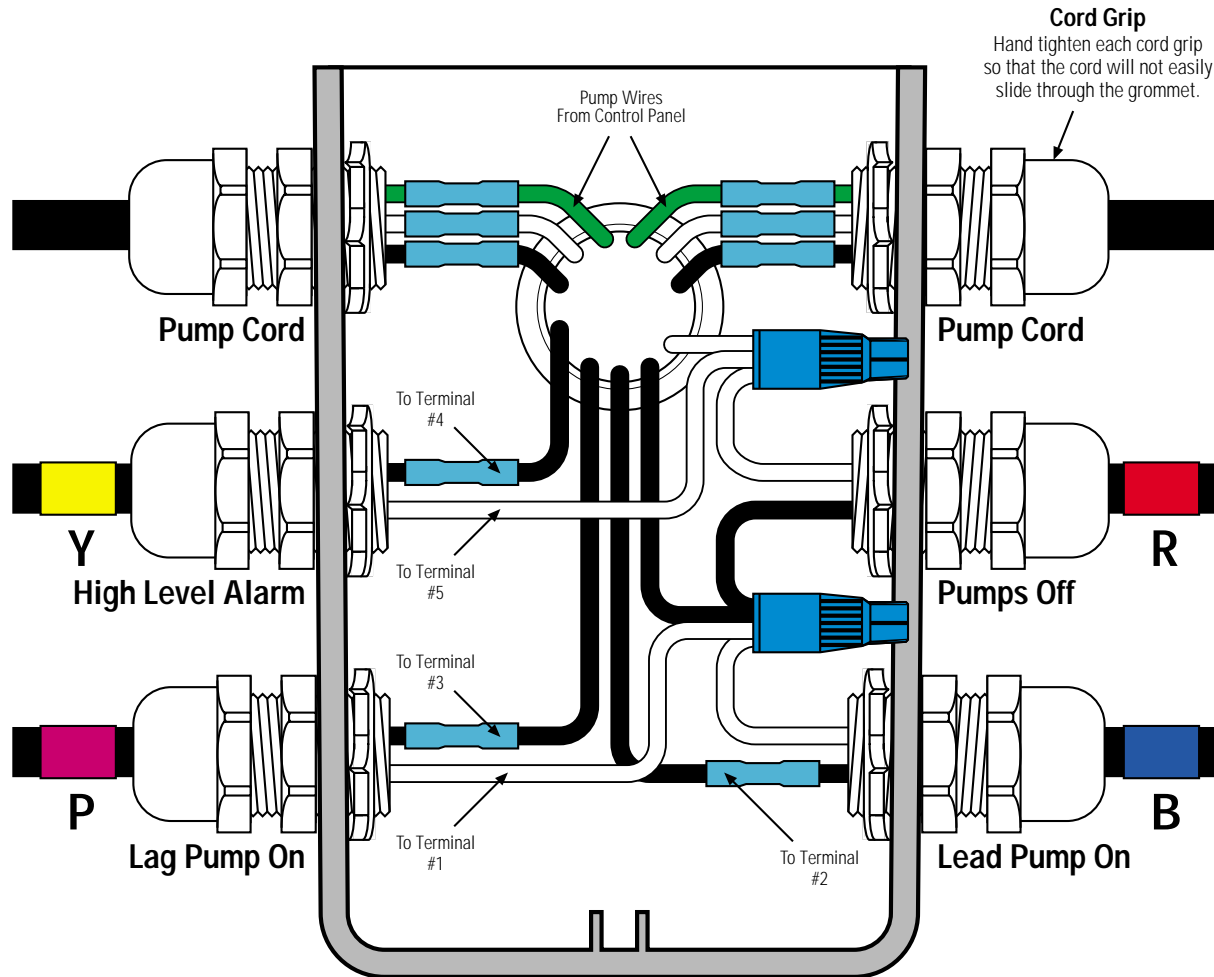

(541) 459-4449

FACSIMILE:

(541) 459-2884



Key

-  Black Wire
-  White Wire
-  Green Wire
-  Waterproof Wire Nut
-  Heat Shrink & Butt Connector *

* Refer to drawing EIN-SB-SB-1 for splicing instructions.

Float Tag Colors

- Y** - Yellow
- P** - Purple
- B** - Blue
- G** - Green
- R** - Red
- O** - Orange
- E** - Grey
- W** - White

Note: Multi-function floats will have more than one marker

Attention: Failure to follow splicing instructions will void warranty

Control Panel Series

DAX

Float Function Color Code

YPBR

Splice Box Model

SB6

Drawing No.

EDW-SB-DAX-3

EDW-SB-DAX-3
Rev 1.1 ©04/23/96