

# SUBMERSIBLE LIGHT SLURRY PUMP

Series: KAG  
Model: 2KAG303 / 304  
3 HP / 3450 RPM  
Discharge: 2"



► Built-in high chrome alloy agitator.

## DISCHARGE

2" vertical / horizontal hose coupling. Cast iron  
ASTM A-48 class 30.

## LIQUID TEMPERATURE

104 °F (40 °C)

## UPPER COVER

Cast iron ASTM A-48 class 30.

## PUMP BODY

Cast iron ASTM A-48 class 30.

## MOTOR HOUSING

Cast iron ASTM A-48 class 30.

## IMPELLER

**Design:** semi-open.

**Material:** high chrome alloy.

## AGITATOR

High chrome alloy.

## INLET PLATES

Ductile iron & high chrome alloy.

## SHAFT

420 AISI stainless steel.

## HARDWARE

304 series stainless steel.

## O-RINGS

Nitrile rubber (NBR).

## PAINT

Air dry enamel, water based.

## SEAL

**Design:** double mechanical, oil filled chamber.

**Material\*:** SiC-SiC / Carbon-SiC. Stainless steel hardware.

## CORD ENTRY

50 ft of neoprene cord, sealed against moisture.

## MOTOR

Three phase induction motor, 230 & 460 volts, 60 Hz, 3450 RPM. Insulation class F and IP68 protection class.

## STRAINER

Steel.

## HANDLE

Rubber & steel.

## ACCESSORIES

Includes a discharge adapter for NPT threads.

\*SiC: Silicon Carbide

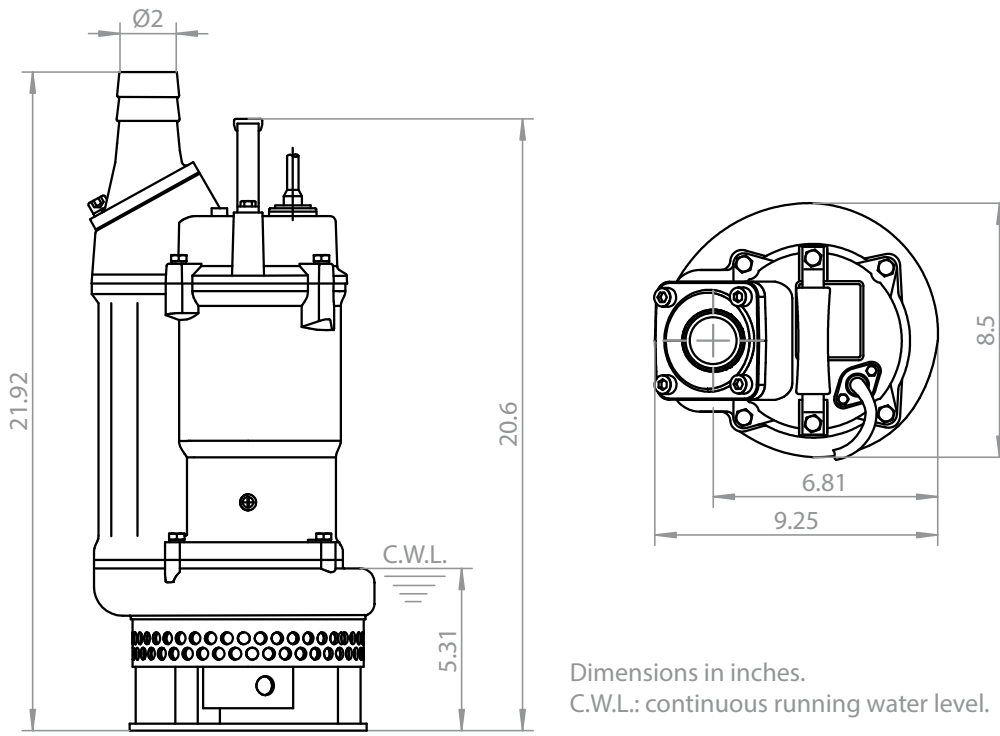

Dimensions in inches.  
C.W.L.: continuous running water level.

MODEL	PART No.	DISCHARGE	HP	VOLTS	PHASE	RPM (Nominal)	MAX AMPS	WEIGHT (pounds)
2KAG303	70090263	2	3	230	3	3450	8.2	88
2KAG304	70090264	2	3	460	3	3450	4.1	88

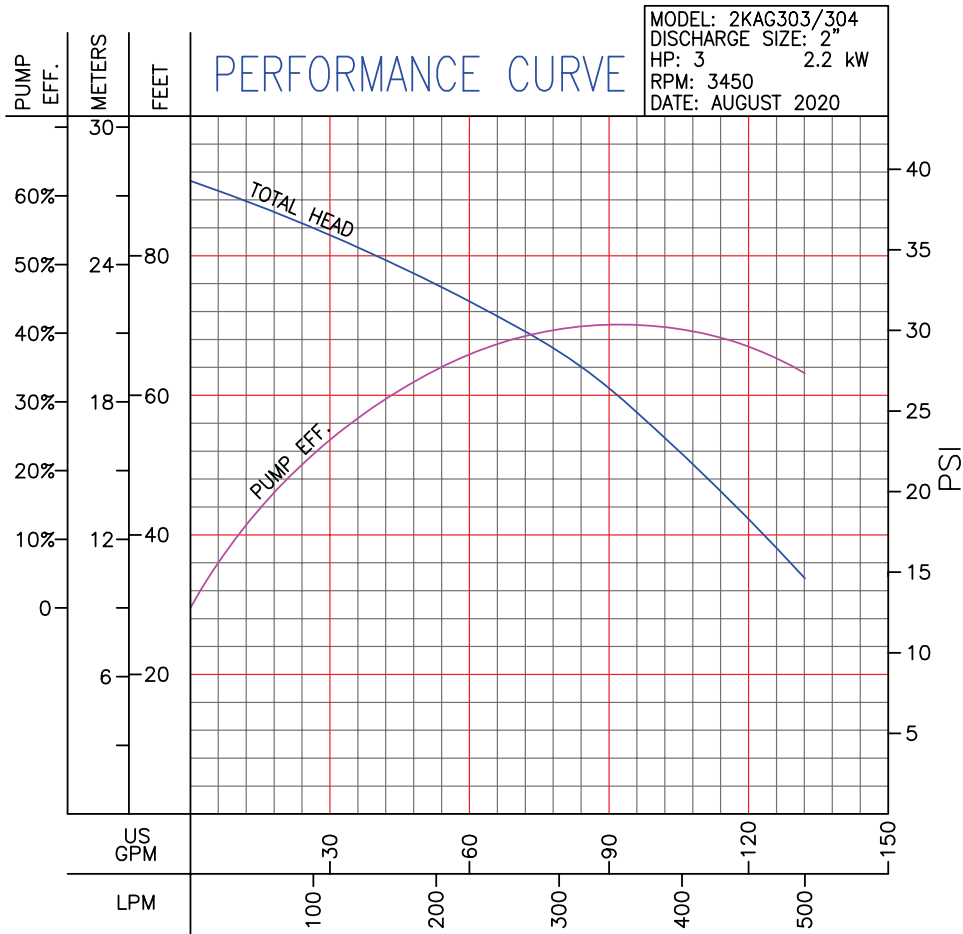

**IMPORTANT!**

1. Never use this pump to handle explosive liquids.
2. This pump is not approved to be used in swimming pools, recreational installations or any application where human contact may be common.
3. Testing is performed with water specific gravity of 1.0 @ 68 °F (20 °C); other fluids may vary performance.