

SUBMERSIBLE SOLIDS HANDLING PUMP

Series: 4BSE-HLDS
7.5-15 HP / 1750 RPM
Discharge: 4"
Spherical solids handling: 3"



DISCHARGE

4", 125lb, flange horizontal.

LIQUID TEMPERATURE

104°F (40°C) continuous

VOLUTE

Cast iron ASTM A-48 class 30

MOTOR HOUSING

Cast iron ASTM A-48 class 30

SEAL PLATE

Cast iron ASTM A-48 class 30

IMPELLER

Design: 2 vane, closed, with vanes on back side.

Material: cast iron ASTM A-48 class 30

SHAFT

416 series stainless steel

SQUARE RINGS

Buna-N

PAINT

Air dry enamel, water based.

SEAL

Design: double, mechanical, oil filled chamber.

Material: silicon carbide outboard seal, carbon ceramic inboard seal, Buna-N elastomer and stainless steel hardware.

DIAPHRAGM

Buna-N

HARDWARE

300 series stainless steel

CORD ENTRY

25 ft of cord, epoxy sealed housing with secondary pressure grommet for sealing and strain relief.

BEARINGS

Upper: ball, single row, oil lubricated, for radial load.

Lower: ball, single row, oil lubricated, for radial and thrust load.

MOTOR

NEMA B, three phase, 230 & 460 volts, 60 Hz, 1750 RPM, oil filled. Requires overload protection to be included in control panel.

MOISTURE SENSOR

Normally open (N/O) included, requires relay in control panel.

TEMPERATURE SENSOR

Normally closed (N/C) included, requires relay in control panel.

OPTIONAL EQUIPMENT

Additional cord, tungsten carbide seal, slide rail coupling (SRC-4).

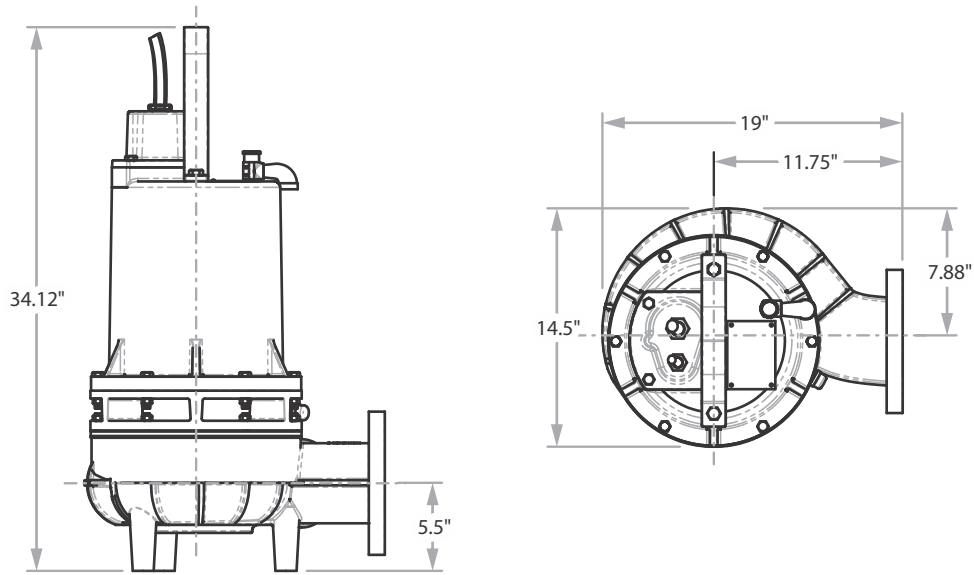

MODEL	PART No.	HP	VOLTS	PHASE	RPM (Nominal)	MAX AMPS	LOCKED ROTOR AMPS	NEMA CODE	CORD SIZE	CORD TYPE	CORD O. D.	WEIGHT (pounds)
4BSE753HLDS	62170141	7.5	230	3	1750	26.8	80	D	10/4	SO	0.75"	309
4BSE754HLDS	62170142	7.5	460	3	1750	13.4	40	D	10/4	SO	0.75"	309
4BSE1133HLDS	62170143	11.3	230	3	1750	28	126	D	10/4	SO	0.75"	340
4BSE1134HLDS	62170144	11.3	460	3	1750	14	63	D	10/4	SO	0.75"	340
4BSE1503HLDS	62170145	15	230	3	1750	38	160	D	10/4	SO	0.75"	400
4BSE1504HLDS	62170146	15	460	3	1750	19	80	D	10/4	SO	0.75"	400

The moisture cord and/or temperature cord is size 18/5, type SO, Ø0.485", for all models.

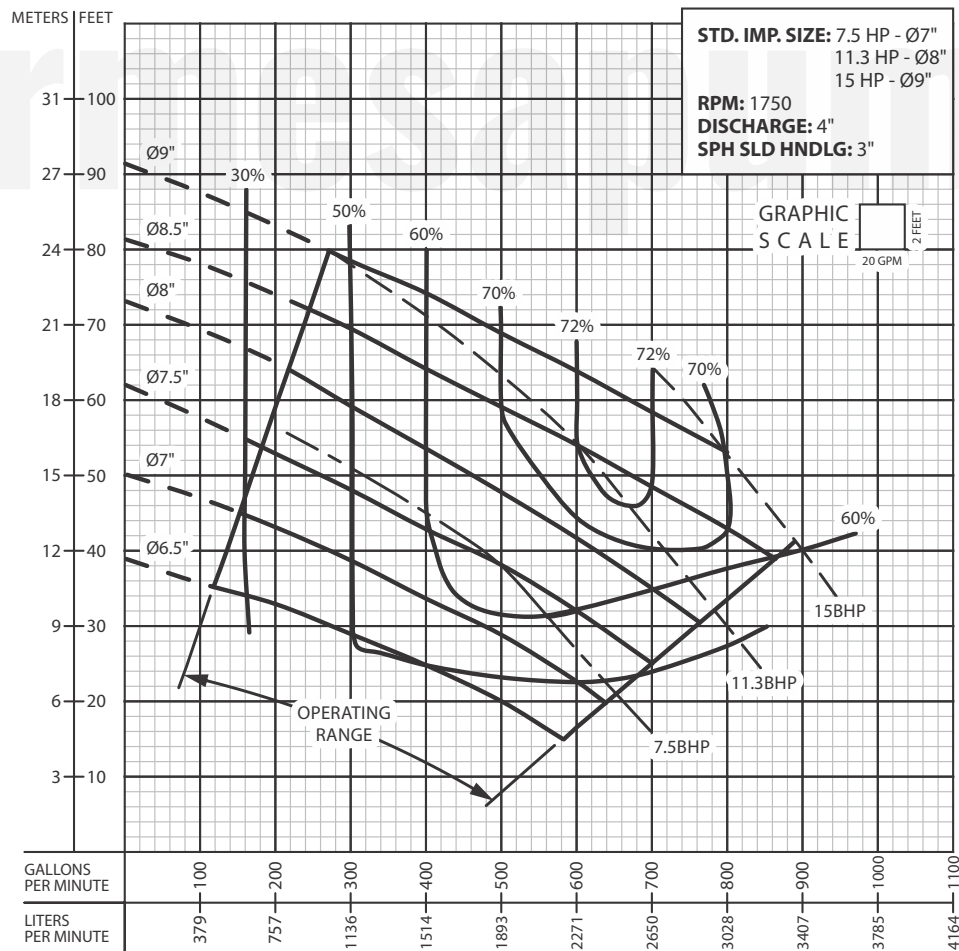

IMPORTANT!

1. Never use this pump to handle explosive liquids.
2. This pump is not approved to be used in swimming pools, recreational installations or any application where human contact may be common.
3. Pump may be operated "dry" for extended periods without damage to motor and/or seals.
4. Testing is performed with water specific gravity of 1.0 @ 68 °F (20 °C); other fluids may vary performance.