

SUBMERSIBLE SLURRY PUMP

Series: **KMUD**

Model: 8KMUD4004

40 HP / 1750 RPM

Discharge: 8"



► Built-in high chrome alloy agitator.

DISCHARGE

8" vertical for hose coupling. Cast iron ASTM A-48 class 30.

LIQUID TEMPERATURE

104 °F (40 °C)

UPPER COVER

Cast iron ASTM A-48 class 30

PUMP BODY

Cast iron ASTM A-48 class 30

MOTOR HOUSING

Cast iron ASTM A-48 class 30

IMPELLER

Design: semi-open

Material: high chrome alloy

AGITATOR

High chrome alloy

INLET PLATES

Cast iron & high chrome alloy

SHAFT

420 AISI stainless steel

HARDWARE

304 series stainless steel

O-RINGS

Nitrile rubber (NBR)

PAINT

Air dry enamel, water based.

SEAL

Design: double mechanical, oil filled chamber.

Material*: TC-SiC / SiC-SiC. Stainless steel hardware.

CORD ENTRY

50 ft of neoprene cord, sealed against moisture.

MOTOR

Three phase induction motor, 460 volts, 60 Hz, 1750 RPM. Insulation class F and IP68 protection class.

STRAINER

Steel

HANDLE

Steel

*TC: Tungsten Carbide, SiC: Silicon Carbide

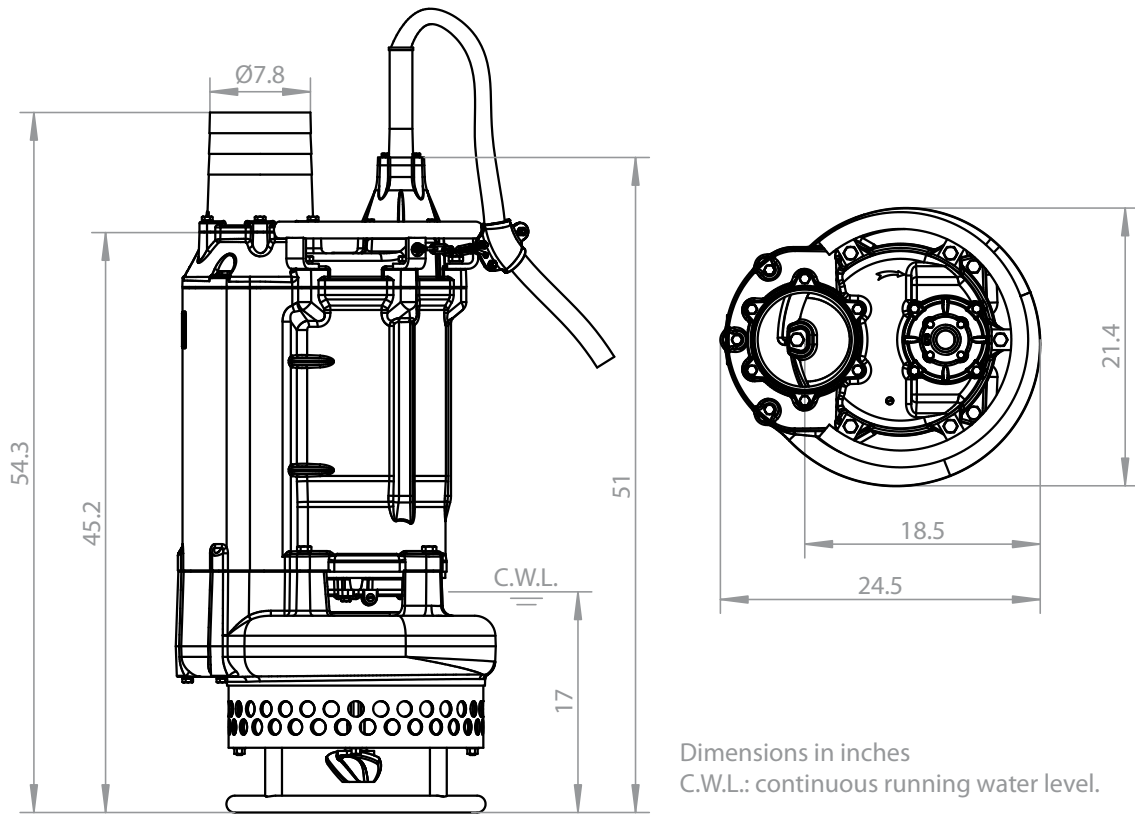

Dimensions in inches
C.W.L.: continuous running water level.

MODEL	PART No.	DISCHARGE	HP	VOLTS	PHASE	RPM (Nominal)	MAX AMPS	WEIGHT (pounds)
8KMUD4004	-	8"	40	460	3	1750	47.6	1124

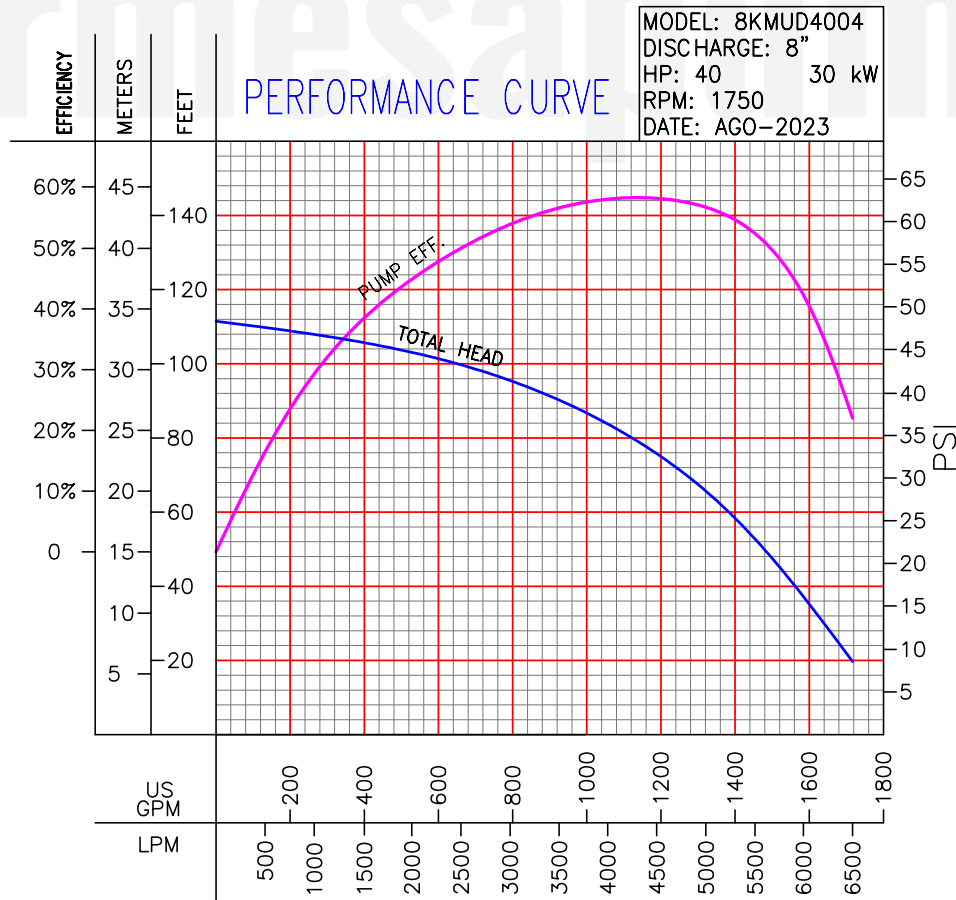

IMPORTANT!

1. Never use this pump to handle explosive liquids.
2. This pump is not approved to be used in swimming pools, recreational installations or any application where human contact may be common.
3. Testing is performed with water specific gravity of 1.0 @ 68 °F (20 °C); other fluids may vary performance.