

VERTICAL MULTI-STAGE CENTRIFUGAL PUMP

Series: BMV150-30-10003
100 HP
Max inlet pressure: 14 bar
Max working pressure: 20 bar



Representative image.

barmesapumps.com

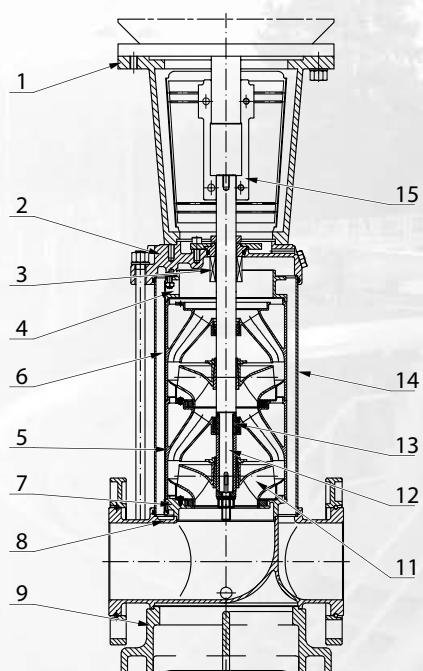

Item	Name	Material	AISI/ASTM
1	Bracket	Cast iron	ASTM25B
2	Pump head	Cast iron	ASTM 80-55-06
3	Mechanical seal		
4	Discharge	Stainless steel	AISI304
5	Support diffuser	Stainless steel	AISI304
6	Diffuser	Stainless steel	AISI304
7	Inducer	Stainless steel	AISI304
8	Inlet and outlet chamber	Cast iron	ASTM 80-55-06
9	Base plate	Cast iron	ASTM 80-55-06
11	Impeller	Stainless steel	AISI304
12	Shaft	Stainless steel	AISI304
13	Bearing	Tungsten carbide	
14	Cylinder	Stainless steel	AISI304
15	Coupling	Carbon steel	
	Rubber parts	NBR	

