

VERTICAL MULTI-STAGE CENTRIFUGAL PUMP

Series: BMV42-30-2503
25 HP

Max inlet pressure: 26 bar
Max working pressure: 16 bar



Representative image.

barmesapumps.com

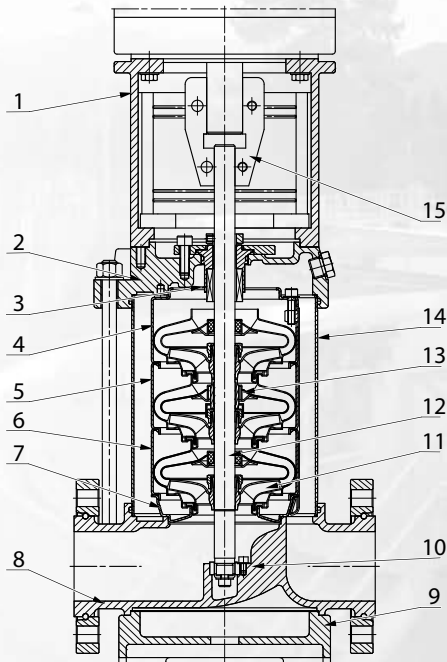

Item	Name	Material	AISI/ASTM
1	Bracket	Cast iron	ASTM25B
2	Pump head	Cast iron	ASTM25B
3	Mechanical seal		
4	Top diffuser	Stainless steel	AISI304
5	Support diffuser	Stainless steel	AISI304
6	Diffuser	Stainless steel	AISI304
7	Inducer	Stainless steel	AISI304
8	Inlet and outlet chamber	Cast iron	ASTM25B
9	Base plate	Cast iron	ASTM25B
10	Bottom bearing	Tungsten carbide	
11	Impeller	Stainless steel	AISI304
12	Shaft	Stainless steel	AISI316L ANSI 431
13	Intermediate bearing	Tungsten carbide	
14	Cylinder	Stainless steel	AISI304
15	Coupling	Carbon steel	
	Rubber parts	NBR	

