

VERTICAL MULTI-STAGE CENTRIFUGAL PUMP

Series: BMV4-60-303

3 HP

Max inlet pressure: 21 bar

Max working pressure: 25 bar



Representative image.

barmesapumps.com

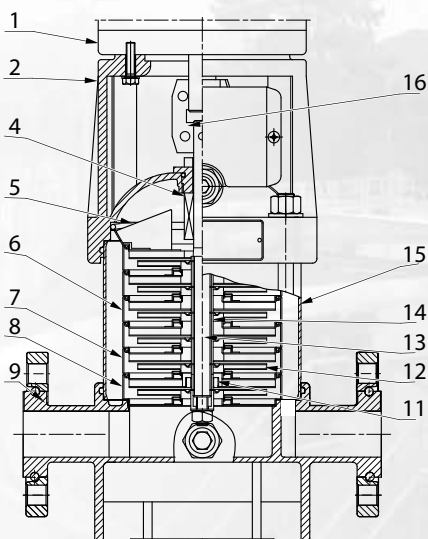

Item	Name	Material	AISI/ASTM
1	Motor		
2	Pump Head	Cast iron	ASTM25B
4	Mechanical seal		
5	Top diffuser	Stainless steel	AISI304
6	Diffuser	Stainless steel	AISI304
7	Support diffuser	Stainless steel	AISI304
8	Inducer	Stainless steel	AISI304
9	Inlet and outlet chamber	Cast iron	ASTM25B
11	Bearing	Tungsten carbide	
12	Impeller	Stainless steel	AISI304
13	Shaft	Stainless steel	AISI304 AISI316L
14	Impeller sleeve	Stainless steel	AISI304
15	Cylinder	Stainless steel	AISI304
16	Coupling	Carbon steel	

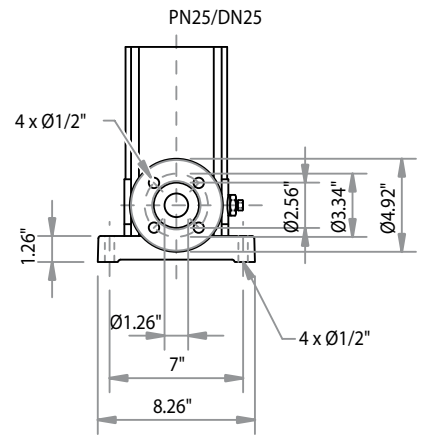
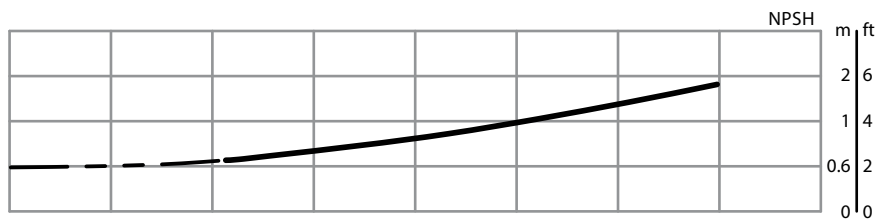
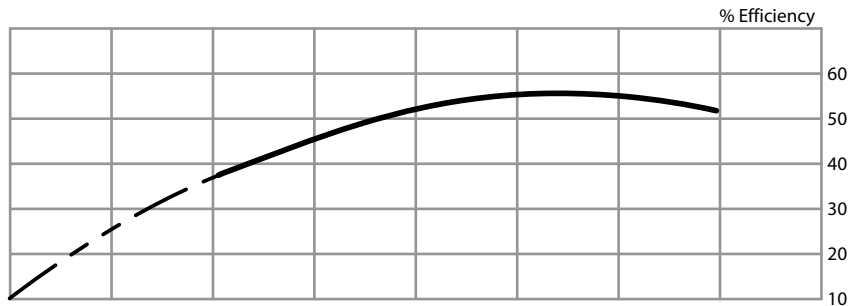
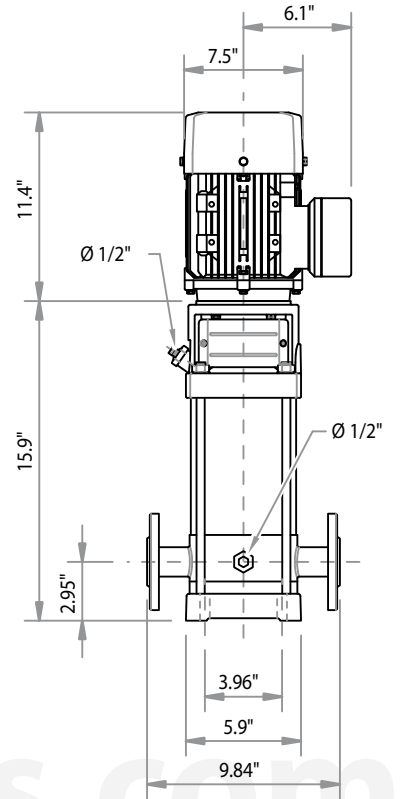
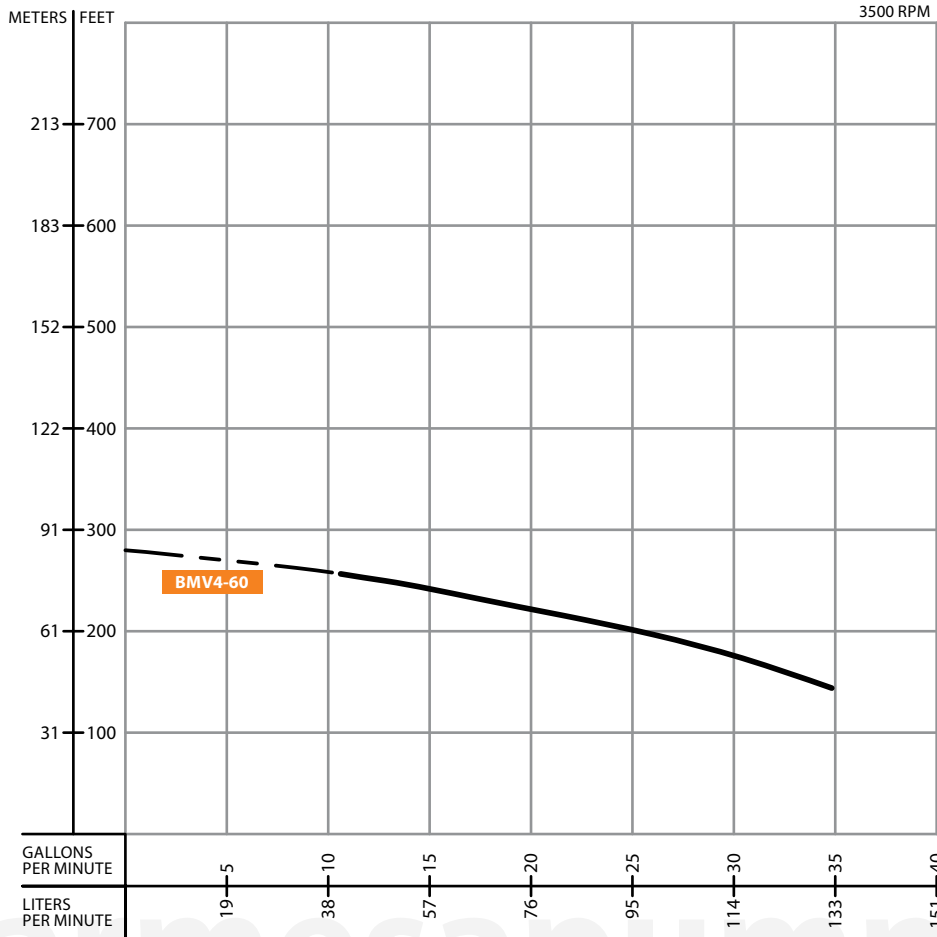

barmesapumps.com