

HIGH EFFICIENCY VERTICAL MULTISTAGE CENTRIFUGAL PUMP

Series: **HMV14-190-553**
5 HP



* Representative image

TECHNICAL DATA								
MODEL	PART No.	HP	RPM	V	MAX. AMPS	MAX. TEMP. (°F)	MAX. Q (gpm)	MAX. H (ft)
HMV14-30-103	70120103A	1	3500	230/460	2.9/1.5	248	20	130
HMV14-50-153	70120103B	1.5	3500	230/460	4.2/2.1	248	20	203
HMV14-70-203	70120103C	2	3500	230/460	5.5/2.7	248	20	295
HMV14-90-303	70120103L	3	3500	230/460	7.9/3.9	248	20	367
HMV14-110-303	70120103D	3	3500	230/460	7.9/3.9	248	20	459
HMV14-130-403	-	4	3500	230/460	7.9/3.9	248	20	541
HMV14-150-403	70120103E	4	3500	230/460	10.3/5.1	248	20	623
HMV14-170-553	70120103P	5.5	3500	230/460	13.5/6.7	248	20	714
HMV14-190-553	70120103F	5.5	3500	230/460	13.5/6.7	248	20	794

ITEM	NAME	MATERIAL	AISI/ASTM
1	Motor	-	-
2	Bracket	Ductile cast iron	ASTM A536 65-45-12
3	Seal base	Stainless steel	AISI 304
4	Mechanical seal	SiC/Carbon	-
5	Top diffuser	Stainless steel	AISI 304
6	Diffuser	Stainless steel	AISI 304
7	Support diffuser	Stainless steel	AISI 304
8	Coupling	Ductile cast iron	ASTM A536 65-45-12
9	Impeller	Stainless steel	AISI 304
10	Cylinder	Stainless steel	AISI 304
11	Shaft	Stainless steel	AISI 304
12	Bearing	Tungsten carbide	-
13	Inducer	Stainless steel	AISI304
14	Inlet & outlet chamber	Stainless steel	AISI 304
15	Base	Cast iron	ASTM 25B

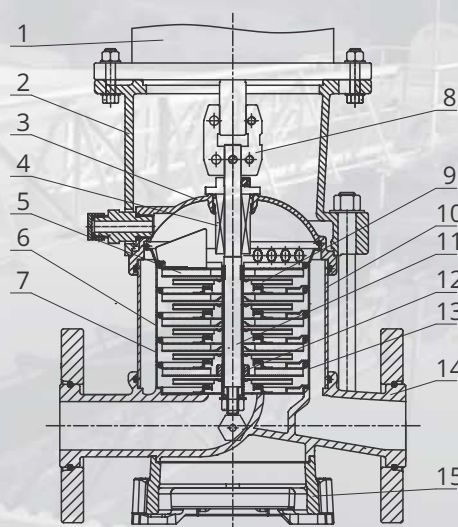

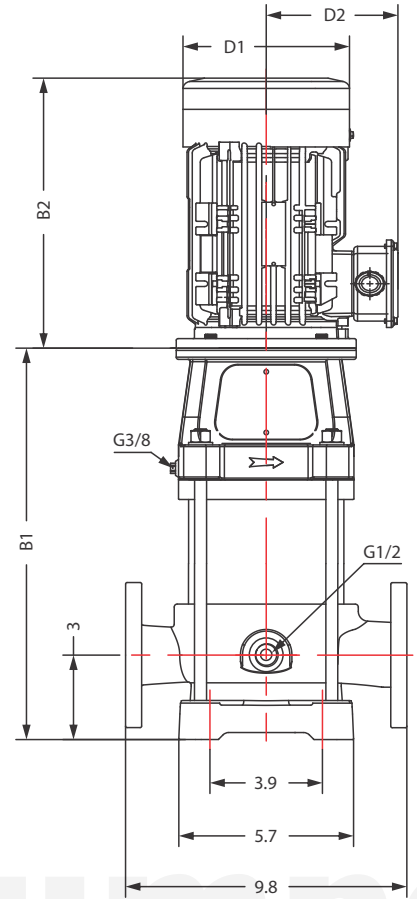
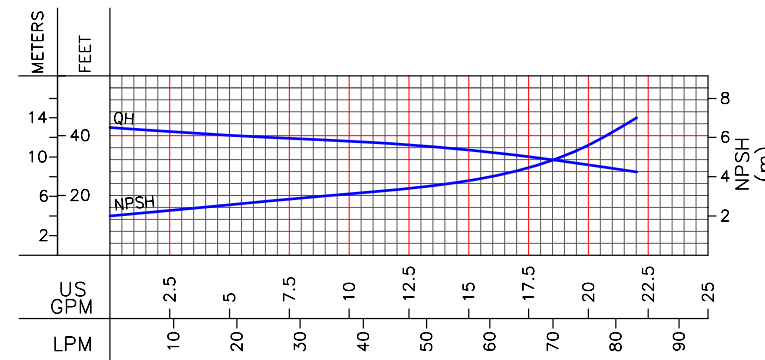
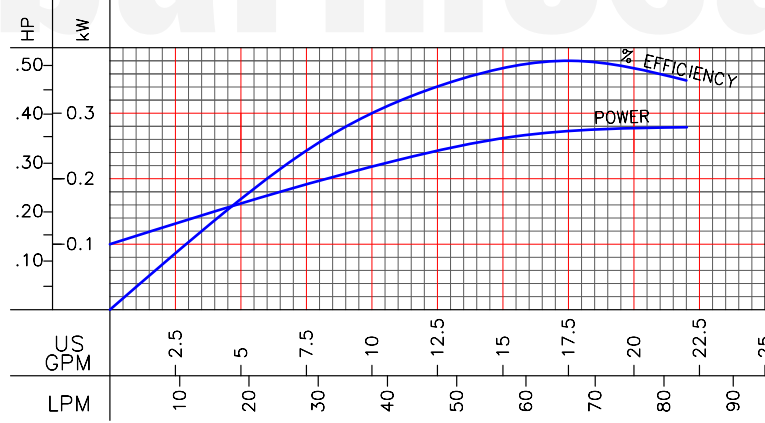
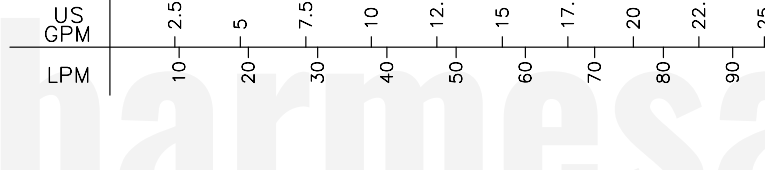
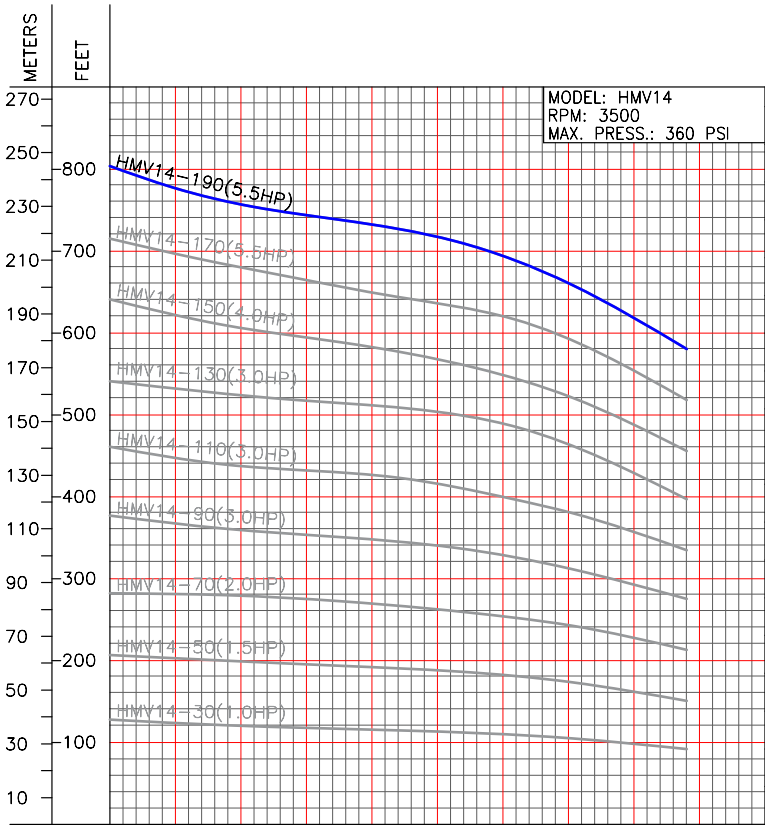

1 1/4" / ANSI / CLASS 300

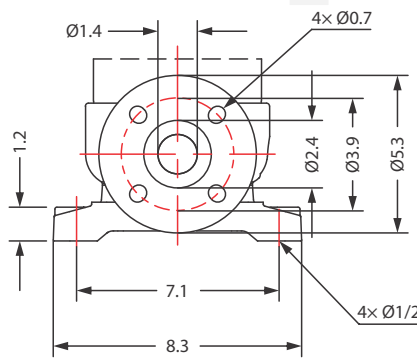

MODEL	HP	STAGES	SIZE (in)				WEIGHT (lb)	
			B1	B2	B1+B2	D1		D2
HMV14-30-103	1	3	11	11	22	7	6	64
HMV14-50-153	1.5	5	13	11	24	7	6	71
HMV14-70-203	2	7	15	14	28	7	6	86
HMV14-90-303	3	9	16	14	30	7	6	101
HMV14-110-303	3	11	17	14	31	7	6	106
HMV14-130-403	4	13	19	16	35	8	6	119
HMV14-150-403	4	15	21	16	37	8	6	123
HMV14-170-553	5	17	22	16	38	9	7	130
HMV14-190-553	5	19	24	16	40	9	7	132