

HIGH EFFICIENCY VERTICAL MULTISTAGE CENTRIFUGAL PUMP

Series: **HMV200-20-2003**
20 HP



* Representative image

TECHNICAL DATA								
MODEL	PART No.	HP	RPM	V	MAX. AMPS	MAX. TEMP. (°F)	MAX. Q (gpm)	MAX. H (ft)
HMV200-10-1-1003	70120115A	10	3500	230/460	18.3/9.1	248	292	124
HMV200-10-1003	70120115B	10	3500	230/460	24.7/12.3	248	292	131
HMV200-20-2003	70120115C	20	3500	230/460	46/23	248	292	255
HMV200-30-2-2503	70120115D	25	3500	230/460	56.5/28.2	248	292	387
HMV200-30-3003	70120115E	30	3500	230/460	66.9/33.5	248	292	390
HMV200-40-4003	70120115F	40	3500	230/460	90.7/45.4	248	292	511
HMV200-50-5003	70120115G	50	3500	230/460	111/55.7	248	292	508
HMV200-70-2-6003	70120115H	60	3500	230/460	134/66.8	248	292	878
HMV200-80-2-7503	70120115I	75	3500	230/460	163/81.3	248	292	1009

ITEM	NAME	MATERIAL	AISI/ASTM
1	Motor	-	-
2	Bracket	Ductile cast iron	ASTM A536 65-45-12
3	Seal base	Stainless steel	AISI 304
4	Mechanical seal	SiC/Carbon	-
5	Top diffuser	Stainless steel	AISI 304
6	Diffuser	Stainless steel	AISI 304
7	Support diffuser	Stainless steel	AISI 304
8	Coupling	Ductile iron	ASTM A536 65-45-12
9	Impeller	Stainless steel	AISI 304
10	Cylinder	Stainless steel	AISI 304
11	Shaft	Stainless steel	AISI 304
12	Bearing	Tungsten carbide	-
13	Inducer	Stainless steel	AISI 304
14	Inlet & outlet chamber	Stainless steel	AISI 304
15	Base	Cast iron	ASTM 25B

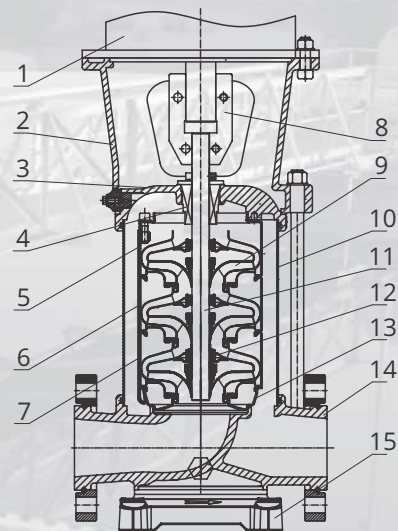

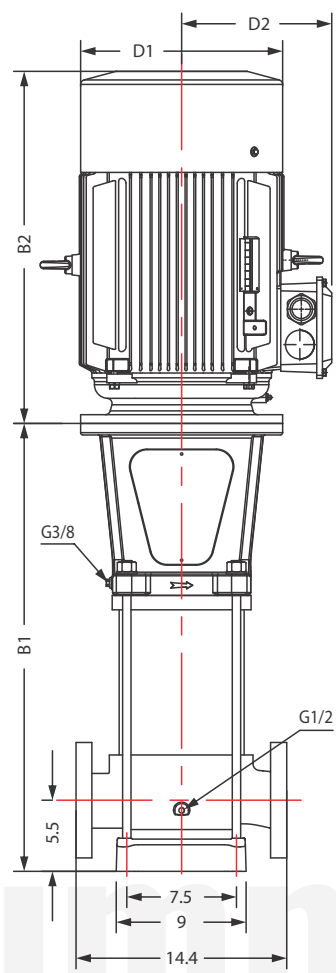
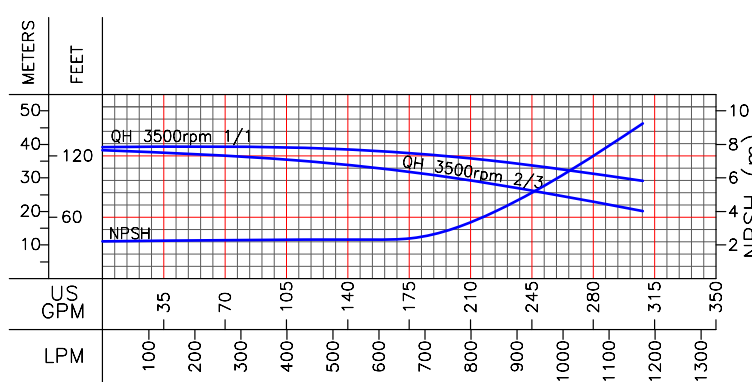
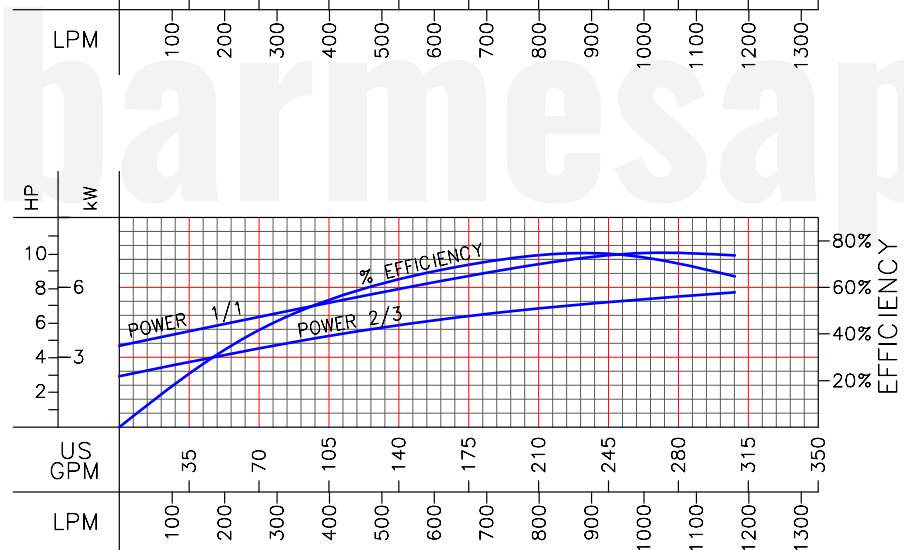
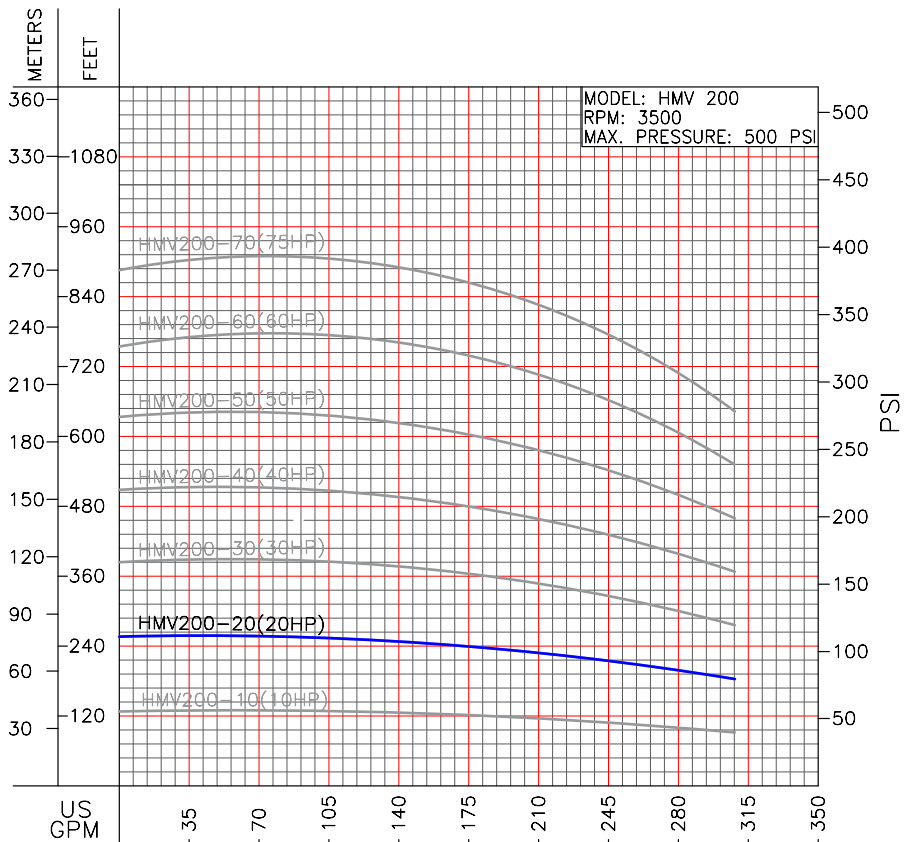

3" / ANSI / CLASS 300

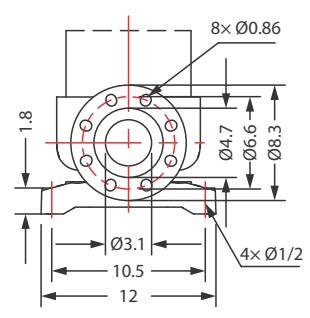

MODEL	HP	STAGES	SIZE (in)			D1	D2	WEIGHT (lb)
			B1	B2	B1+B2			
HMV200-10-1-1003	10	1	20	18	38	10	8	227
HMV200-10-1-1003	10	1	20	18	38	10	8	249
HMV200-20-2-2003	20	2	27	24	51	14	10	452
HMV200-30-2-2503	25	3	31	25	56	14	10	496
HMV200-30-3-3003	30	3	31	26	57	14	11	573
HMV200-40-4-4003	40	4	34	28	62	16	12	694
HMV200-50-5-5003	50	5	37	28	65	16	12	750
HMV200-70-2-6003	60	7	43	29	72	18	13	915
HMV200-80-2-7503	75	8	47	32	80	22	15	1091