

# HIGH EFFICIENCY VERTICAL MULTISTAGE CENTRIFUGAL PUMP

Series: **HMV45-60-753**  
7.5 HP



\* Representative image

TECHNICAL DATA								
MODEL	PART No.	HP	RPM	V	MAX. AMPS	MAX. TEMP. (°F)	MAX. Q (gpm)	MAX. H (ft)
HMV45-20-303	70120107A	3	3500	230/460	7.9/3.9	248	65	137
HMV45-30-403	70120107B	4	3500	230/460	10.3/5.1	248	65	203
HMV45-40-553	70120107C	5.5	3500	230/460	13.5/6.7	248	65	262
HMV45-50-753	70120107H	7.5	3500	230/460	18.3/9.1	248	65	334
HMV45-60-753	70120107D	7.5	3500	230/460	18.3/9.1	248	65	407
HMV45-70-1003	70120107J	10	3500	230/460	24.7/12.3	248	65	460
HMV45-80-1003	70120107E	10	3500	230/460	24.7/12.3	248	65	530
HMV45-90-1503	70120107L	15	3500	230/460	34/17	248	65	592
HMV45-100-1503	70120107N	15	3500	230/460	34/17	248	65	662
HMV45-110-1503	70120107P	15	3500	230/460	34/17	248	65	728
HMV45-120-1503	70120107F	15	3500	230/460	34/17	248	65	787
HMV45-130-2003	70120107R	20	3500	230/460	46/23	248	65	859
HMV45-140-2003	70120107T	20	3500	230/460	46/23	248	65	921
HMV45-150-2003	70120107V	20	3500	230/460	46/23	248	65	996
HMV45-160-2003	70120107G	20	3500	230/460	46/23	248	65	1055

ITEM	NAME	MATERIAL	AISI/ASTM
1	Motor	-	-
2	Bracket	Ductile cast iron	ASTM A536 65-45-12
3	Seal base	Stainless steel	AISI 304
4	Mechanical seal	SiC/Carbon	-
5	Top diffuser	Stainless steel	AISI 304
6	Diffuser	Stainless steel	AISI 304
7	Support diffuser	Stainless steel	AISI 304
8	Coupling	Ductile iron	ASTM A536 65-45-12
9	Impeller	Stainless steel	AISI 304
10	Cylinder	Stainless steel	AISI 304
11	Shaft	Stainless steel	AISI 304
12	Bearing	Tungsten carbide	-
13	Inducer	Stainless steel	AISI 304
14	Inlet & outlet chamber	Stainless steel	AISI 304
15	Base	Cast iron	ASTM 25B

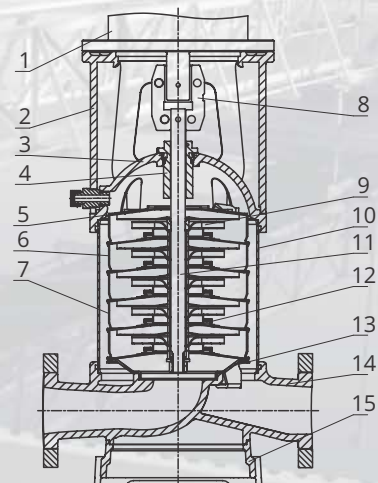

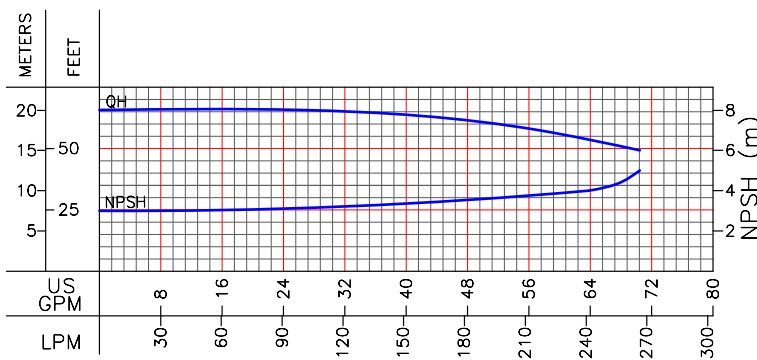
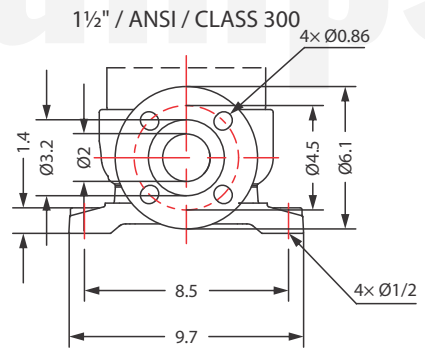
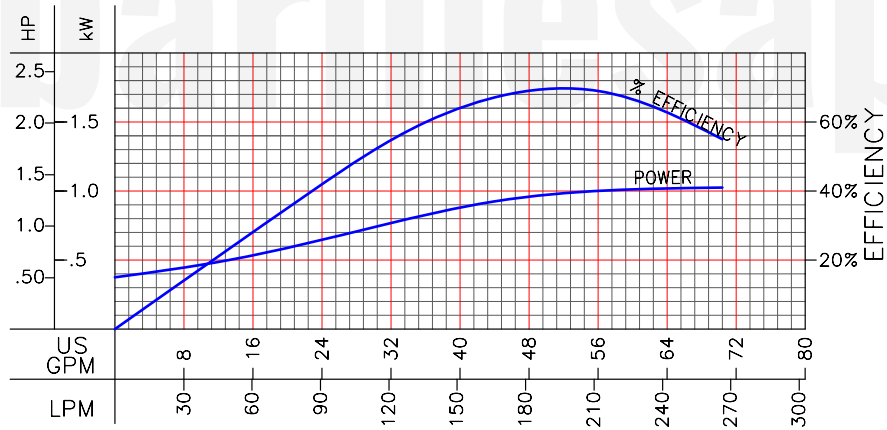
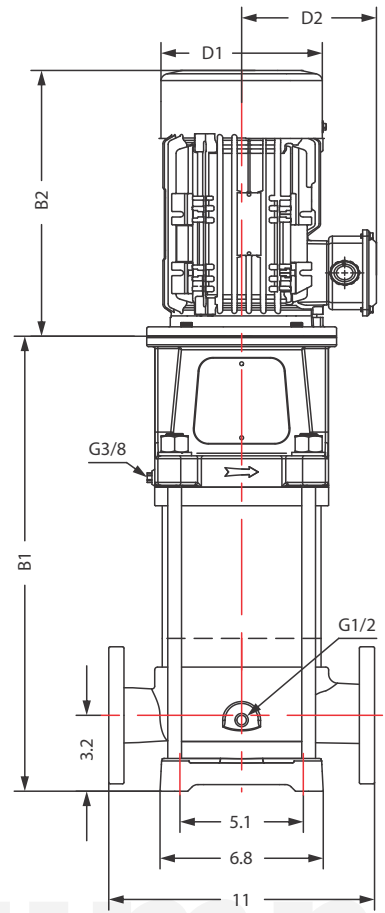
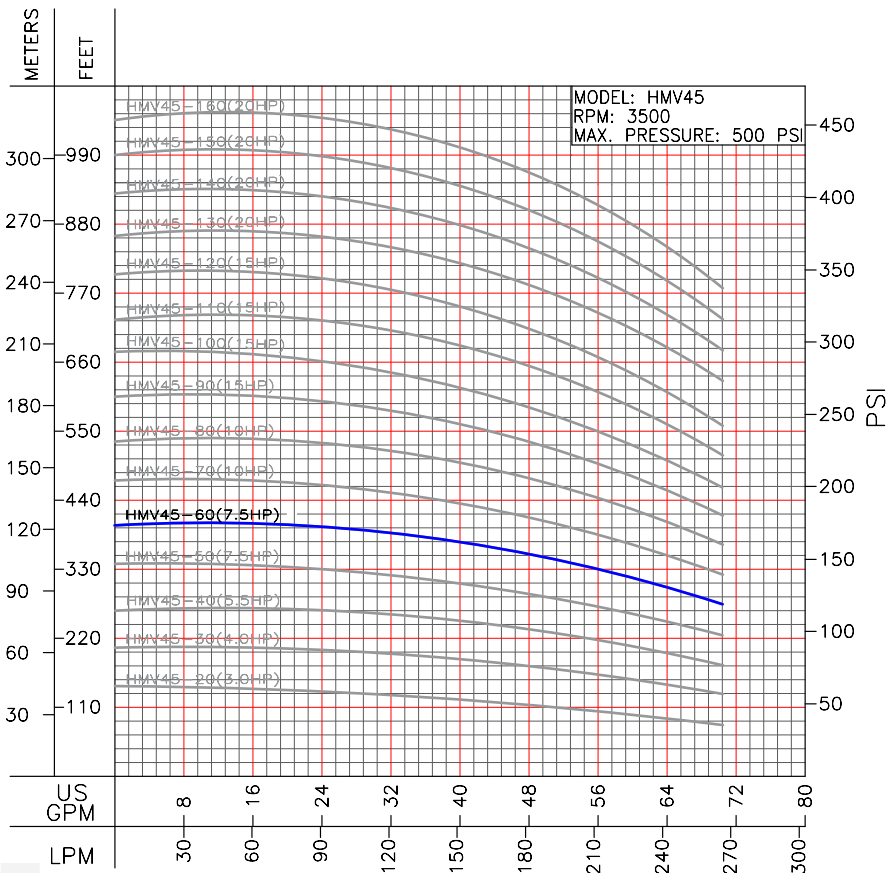

MODEL	HP	STAGES	SIZE (in)				WEIGHT (lb)	
			B1	B2	B1+B2	D1		D2
HMV45-20-303	3	2	14	14	28	7	6	93
HMV45-30-403	4	3	16	16	32	8	6	106
HMV45-40-553	5.5	4	17	16	33	9	7	128
HMV45-50-753	7.5	5	19	18	37	10	8	154
HMV45-60-753	7.5	6	20	18	39	10	8	157
HMV45-70-1003	10	7	21	18	40	10	8	176
HMV45-80-1003	10	8	23	18	41	10	8	179
HMV45-90-1503	15	9	27	24	51	14	10	335
HMV45-100-1503	15	10	28	24	52	14	10	335
HMV45-110-1503	15	11	30	24	54	14	10	337
HMV45-120-1503	15	12	31	24	55	14	10	340
HMV45-130-2003	20	13	32	24	56	14	10	379
HMV45-140-2003	20	14	33	24	57	14	10	381
HMV45-150-2003	20	15	34	24	58	14	10	384
HMV45-160-2003	20	16	36	24	60	14	10	386