

Self-Priming Universal/Electric Driven

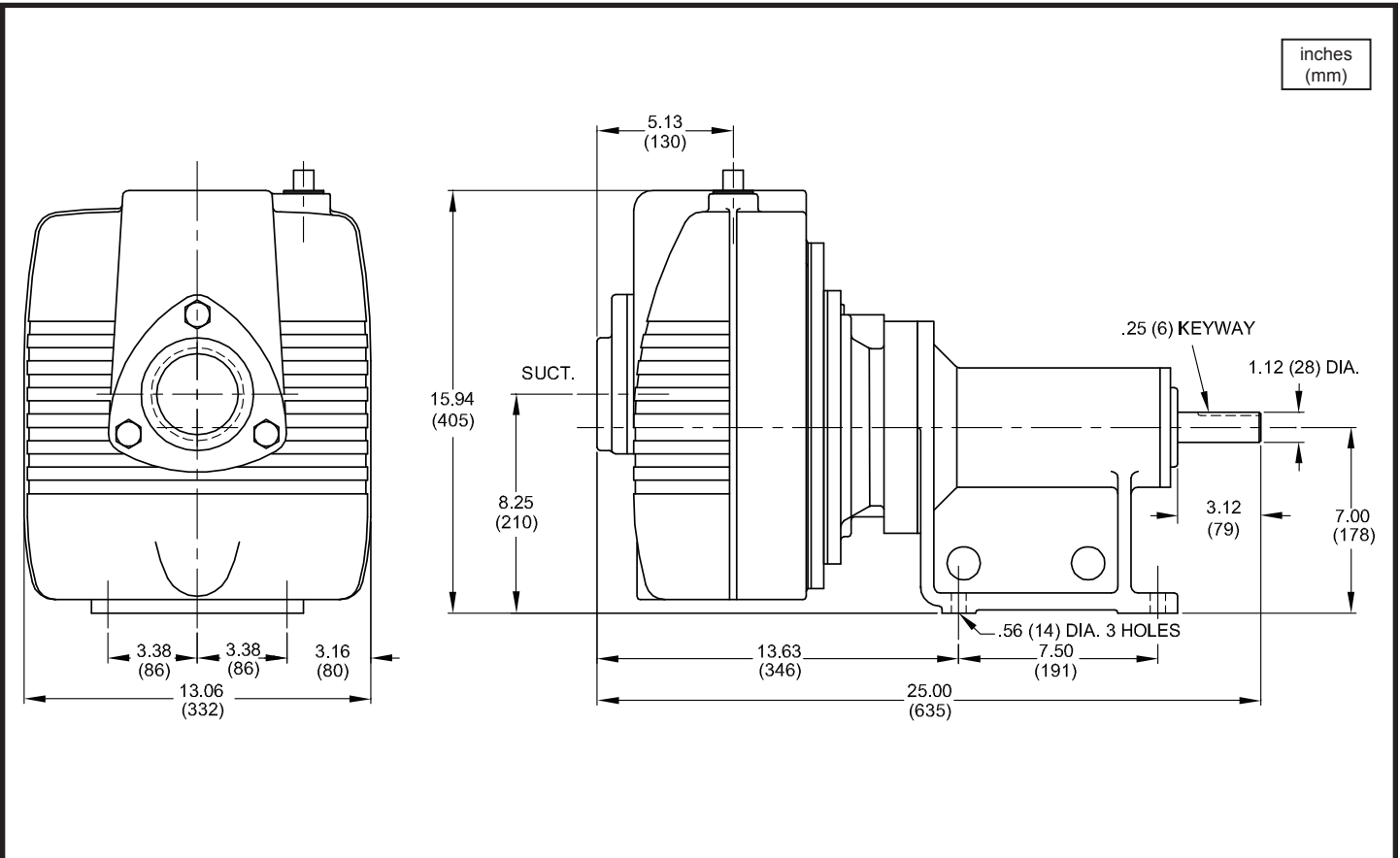

MODEL NO	PART NO	WEIGHT NET LBS (kg)	
20ICU-1	052624	223 (101)	

IMPORTANT !

- DO NOT USE FOR PUMPING FLUIDS WITH A FLASH POINT OF LESS THAN 100°F.
- MAKE CERTAIN THAT PUMP AND/OR MOTOR ASSEMBLY AND CONTROLS HAVE THE APPROPRIATE RATINGS FOR THE GIVEN APPLICATION AREA CLASSIFICATION. (ie DIVISION I, AGENCY LISTING ETC.)

Series 20ICU-1

Performance Curve

Pump End

BARNES®

www.cranepumps.com

Self-Priming Universal/Electric Driven

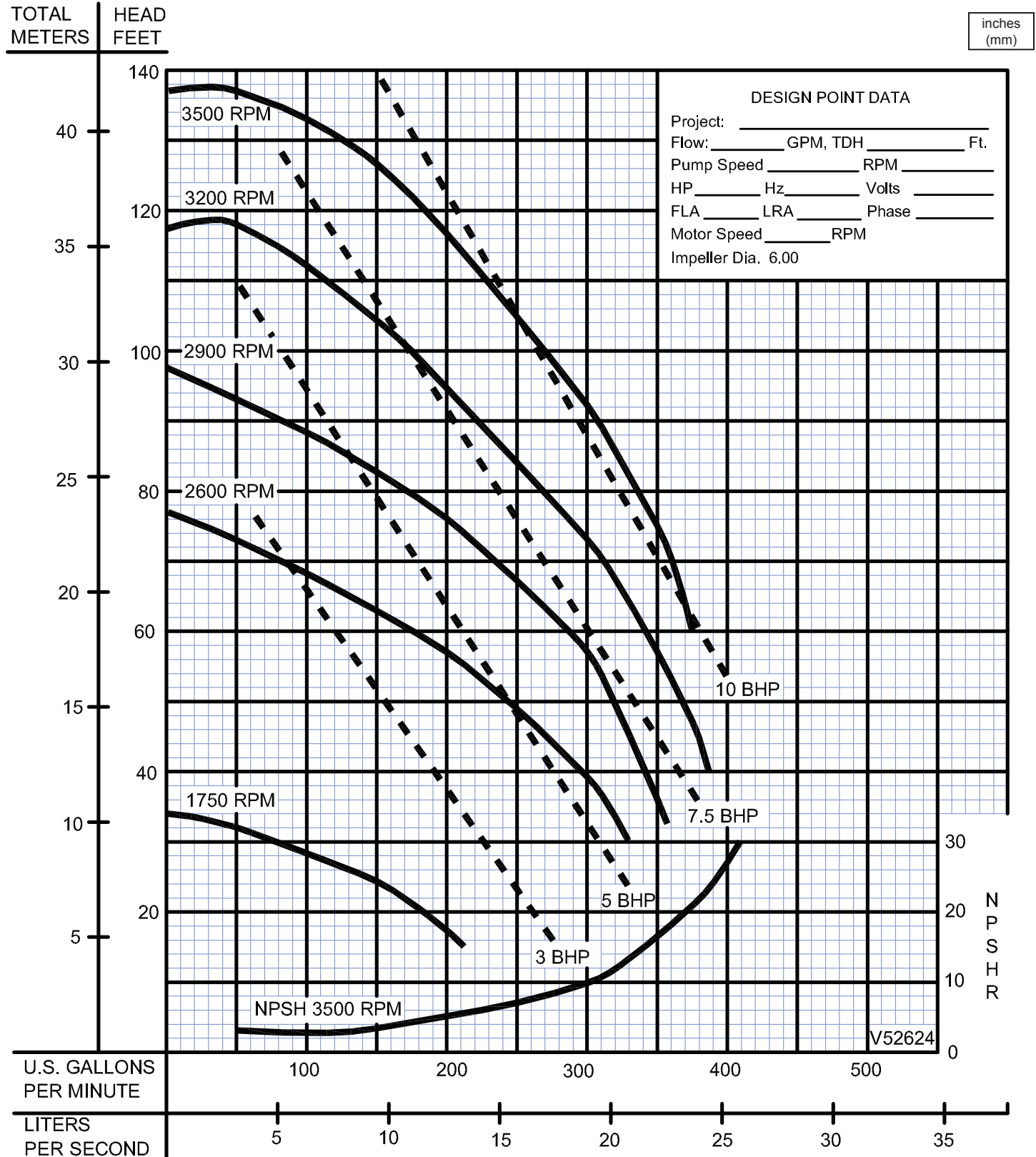

Testing is performed with water, specific gravity 1.0 @ 68° F @ (20°C), other fluids may vary performance

SECTION 4E
PAGE 30
DATE 5/05

CRANE
A Crane Co. Company

PUMPS & SYSTEMS

USA: (937) 778-8947 • Canada: (905) 457-6223 • International: (937) 615-3598