

Size 4D (Dual Vane)

3" Spherical Solids Handling

7365*-425

DEMING®

www.cranepumps.com

Demersible Non-Clog Pumps

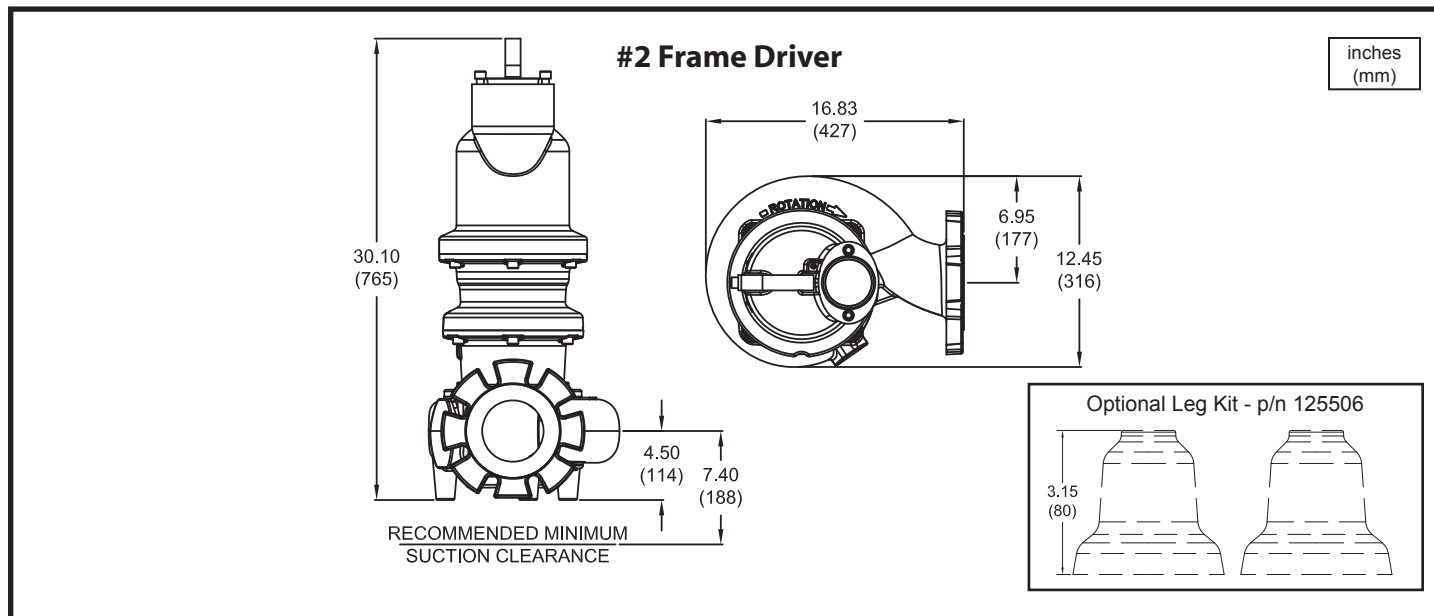

Model No.	Imp. Dia. inches (mm)	HP	Volt	PH	Hz	RPM	NEMA Start Code	Full Load Amps	S.F.	S.F. Amps	Locked Rotor Amps	Cord P/N ▲	Cord Size
7365*-425-26-10N	5.51 (140)	3	208	1	60	1750	D	14.9	1.2	18.5	59.1	125496	12/4 - 18/4
			230				F	14.1	1.2	16.5	66.3	125496	12/4 - 18/4
7365*-425-1P-30N	5.51 (140)	3	208	3	60	1750	K	9.7	1.2	11.4	58.2	125496	12/4 - 18/4
			230					9.2	1.2	10.6	65.8	125496	12/4 - 18/4
			460					4.6	1.2	5.3	32.9	125497	12/4 - 18/4
7365*-425-71-30N	5.51 (140)	3	575	3	60	1750	N	4.5	1.2	4.9	37.0	125497	12/4 - 18/4
7365*-425-27-10N	6.30 (160)	5	208	1	60	1750	D	27.2	1.2	35.6	99.9	125498	8/4 - 18/4
			230				F	25.4	1.2	30.2	112.4	125498	8/4 - 18/4
7365*-425-1R-30N	6.30 (160)	5	208	3	60	1750	J	15.8	1.2	18.7	82.4	125496	12/4 - 18/4
			230					15.0	1.2	17.2	92.4	125496	12/4 - 18/4
			460					7.5	1.2	8.6	46.2	125497	12/4 - 18/4
7365*-425-72-30N	6.30 (160)	5	575	3	60	1750	J	6.0	1.2	6.9	37.0	125497	12/4 - 18/4
7365*-425-1S-30N	7.09 (180)	7.5	208	3	60	1750	H	23.8	1.2	28.5	105.9	125496	12/4 - 18/4
			230					23.7	1.2	27.2	123.6	125496	12/4 - 18/4
			460					11.9	1.2	13.6	61.8	125497	12/4 - 18/4
7365*-425-87-30N	7.09 (180)	7.5	575	3	60	1750	H	9.5	1.2	10.9	49.4	125497	12/4 - 18/4
7365*-425-1T-30N	7.48 (190)	10	208	3	60	1750	E	32.2	1.2	41.4	105.9	125498	8/4 - 18/4
			230					29.8	1.2	35.6	123.6	125498	8/4 - 18/4
			460					14.9	1.2	17.8	61.8	125497	12/4 - 18/4
7365*-425-88-30N	7.48 (190)	10	575	3	60	1750	E	11.9	1.2	14.2	49.4	125497	12/4 - 18/4

* FOR NON-EXPLOSION PROOF (STANDARD) MODELS, USE FIGURE NUMBER 7365N.

▲ CORD SOLD SEPARATELY. CORD SUFFIX: XC - 30 FEET, XF - 50 FEET, XJ - 75 FEET, OR XL - 100 FEET.

IMPORTANT !

- 1.) MOISTURE AND TEMPERATURE SENSORS **MUST** BE CONNECTED TO VALIDATE THE CSA LISTING.
 - 2.) A SPECIAL MOISTURE SENSOR RELAY IS REQUIRED IN THE CONTROL PANEL FOR PROPER OPERATION OF THE MOISTURE SENSORS. CONTACT CP&S FOR INFORMATION CONCERNING MOISTURE SENSING RELAYS FOR CUSTOMER SUPPLIED CONTROL PANELS.
 - 3.) THESE PUMPS ARE CSA LISTED FOR PUMPING WATER AND WASTEWATER. **DO NOT USE TO PUMP FLAMMABLE LIQUIDS.** NOT SUITABLE FOR ENVIRONMENTS CONTAINING GASOLINE OR HEXANE.
 - 4.) INSTALLATIONS SUCH AS DECORATIVE FOUNTAINS OR WATER FEATURES PROVIDED FOR VISUAL ENJOYMENT MUST BE INSTALLED IN ACCORDANCE WITH THE NATIONAL ELECTRIC CODE ANSI/NFPA 70 AND/OR THE AUTHORITY HAVING JURISDICTION. THIS PUMP IS NOT INTENDED FOR USE IN SWIMMING POOLS, RECREATIONAL WATER PARKS, OR INSTALLATIONS IN WHICH HUMAN CONTACT WITH PUMPED MEDIA IS A COMMON OCCURRENCE.
 - 5.) A **NON-SPARKING** BREAKAWAY FITTING MUST BE USED TO VALIDATE THE EXPLOSION PROOF LISTING.
 - 6.) WINDING RESISTANCE ± 7.5%. WINDING RESISTANCE MEASURED IN OHMS @ 25°C (BETWEEN LINES) AT MOTOR LEADS.
 - 7.) PUMP RATED FOR OPERATION AT ± 10% VOLTAGE AT MOTOR.
 - 8.) ALL EXPLOSION PROOF PUMPS AND MOTORS ARE CSA EXPLOSION-PROOF TO CLASS I DIVISION 1 GROUPS C&D T4 RATING
- ** CUSTOMER TO SPECIFY IMPELLER DIAMETER WHEN ORDERING.

SECTION 42A
PAGE 34
DATE 2/18

CRANE®

PUMPS & SYSTEMS

A Crane Co. Company

USA: (937) 778-8947 • Canada: (905) 457-6223 • International: (937) 615-3598