

Demersible Non-Clog Pumps

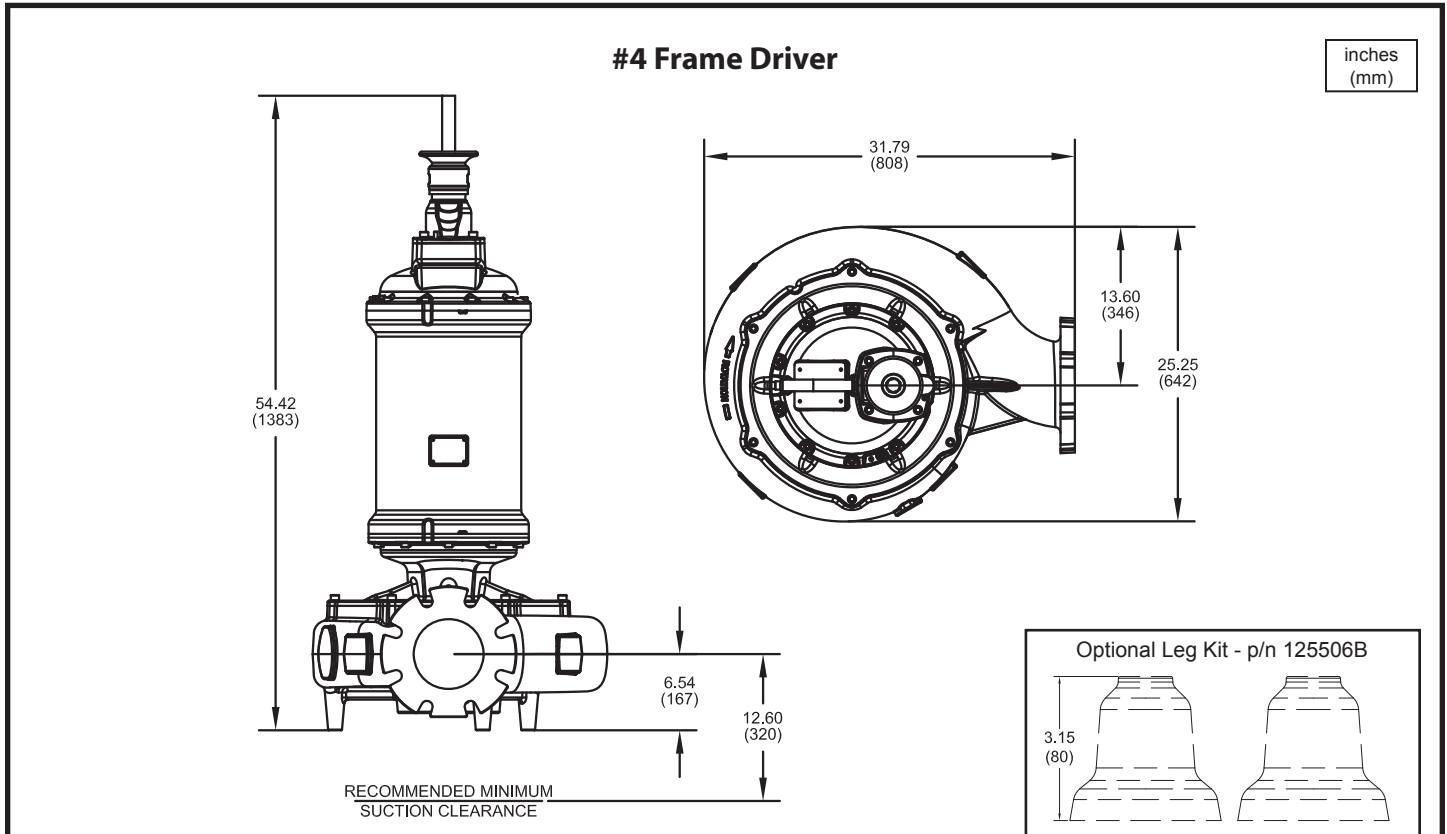

Model No.	Imp. Dia. inches (mm)	HP	Volt	PH	Hz	RPM	NEMA Start Code	Full Load Amps	S.F.	S.F. Amps	Locked Rotor Amps	Cord P/N ▲	Cord Size
7365*-659-31-30N	**	20	208	3	60	870	J	69.0	1.2	76.0	400.0	138318	6/4 - 18/4
			230					75.1		79.0		138318	6/4 - 18/4
7365*-659-91-30N	**	20	460	3	60	870	J	37.6	1.2	41.1	200.0	138317	8/4 - 18/4
7365*-659-1A-30N	**	20	575	3	60	870	J	30.1	1.2	32.9	160.0	138317	8/4 - 18/4
7365*-659-32-30N	**	25	208	3	60	870	H	82.3	1.2	98.8	400.0	138319	2/4 - 18/4
			230					84.0		94.5		138319	2/4 - 18/4
7365*-659-92-30N	**	25	460	3	60	870	H	42.0	1.2	47.2	200.0	138317	8/4 - 18/4
7365*-659-1B-30N	**	25	575	3	60	870	H	33.6	1.2	37.8	160.0	138317	8/4 - 18/4
7365*-659-33-30N	**	30	208	3	60	870	F	98.8	1.2	124.1	400.0	138319	2/4 - 18/4
			230					94.5		108.6		138319	2/4 - 18/4
7365*-659-93-30N	**	30	460	3	60	870	F	47.2	1.2	54.3	200.0	138317	8/4 - 18/4
7365*-659-1C-30N	**	30	575	3	60	870	F	37.8	1.2	43.5	160.0	138317	8/4 - 18/4

* FOR NON-EXPLOSION PROOF (STANDARD) MODELS, USE FIGURE NUMBER 7365N.

▲ CORD SOLD SEPARATELY. CORD SUFFIX: XF - 50 FEET, XJ - 75 FEET, OR XL - 100 FEET.

IMPORTANT !

- 1.) MOISTURE AND TEMPERATURE SENSORS **MUST** BE CONNECTED TO VALIDATE THE CSA LISTING.
 - 2.) A SPECIAL MOISTURE SENSOR RELAY IS REQUIRED IN THE CONTROL PANEL FOR PROPER OPERATION OF THE MOISTURE SENSORS. CONTACT CP&S FOR INFORMATION CONCERNING MOISTURE SENSING RELAYS FOR CUSTOMER SUPPLIED CONTROL PANELS.
 - 3.) THESE PUMPS ARE CSA LISTED FOR PUMPING WATER AND WASTEWATER. **DO NOT USE TO PUMP FLAMMABLE LIQUIDS.** NOT SUITABLE FOR ENVIRONMENTS CONTAINING GASOLINE OR HEXANE.
 - 4.) INSTALLATIONS SUCH AS DECORATIVE FOUNTAINS OR WATER FEATURES PROVIDED FOR VISUAL ENJOYMENT MUST BE INSTALLED IN ACCORDANCE WITH THE NATIONAL ELECTRIC CODE ANSI/NFPA 70 AND/OR THE AUTHORITY HAVING JURISDICTION. THIS PUMP IS NOT INTENDED FOR USE IN SWIMMING POOLS, RECREATIONAL WATER PARKS, OR INSTALLATIONS IN WHICH HUMAN CONTACT WITH PUMPED MEDIA IS A COMMON OCCURRENCE.
 - 5.) A **NON-SPARKING** BREAKAWAY FITTING MUST BE USED TO VALIDATE THE EXPLOSION PROOF LISTING.
 - 6.) WINDING RESISTANCE ± 7.5%. WINDING RESISTANCE MEASURED IN OHMS @ 25°C (BETWEEN LINES) AT MOTOR LEADS.
 - 7.) PUMP RATED FOR OPERATION AT ± 10% VOLTAGE AT MOTOR.
 - 8.) ALL EXPLOSION PROOF PUMPS AND MOTORS ARE CSA EXPLOSION-PROOF TO CLASS I DIVISION 1 GROUPS C&D T4 RATING
- ** CUSTOMER TO SPECIFY IMPELLER DIAMETER WHEN ORDERING.

Size 6VT (Vortex)

3" Spherical Solids Handling

7365*-658, 659

DEMING®

www.cranepumps.com

Demersible Non-Clog Pumps

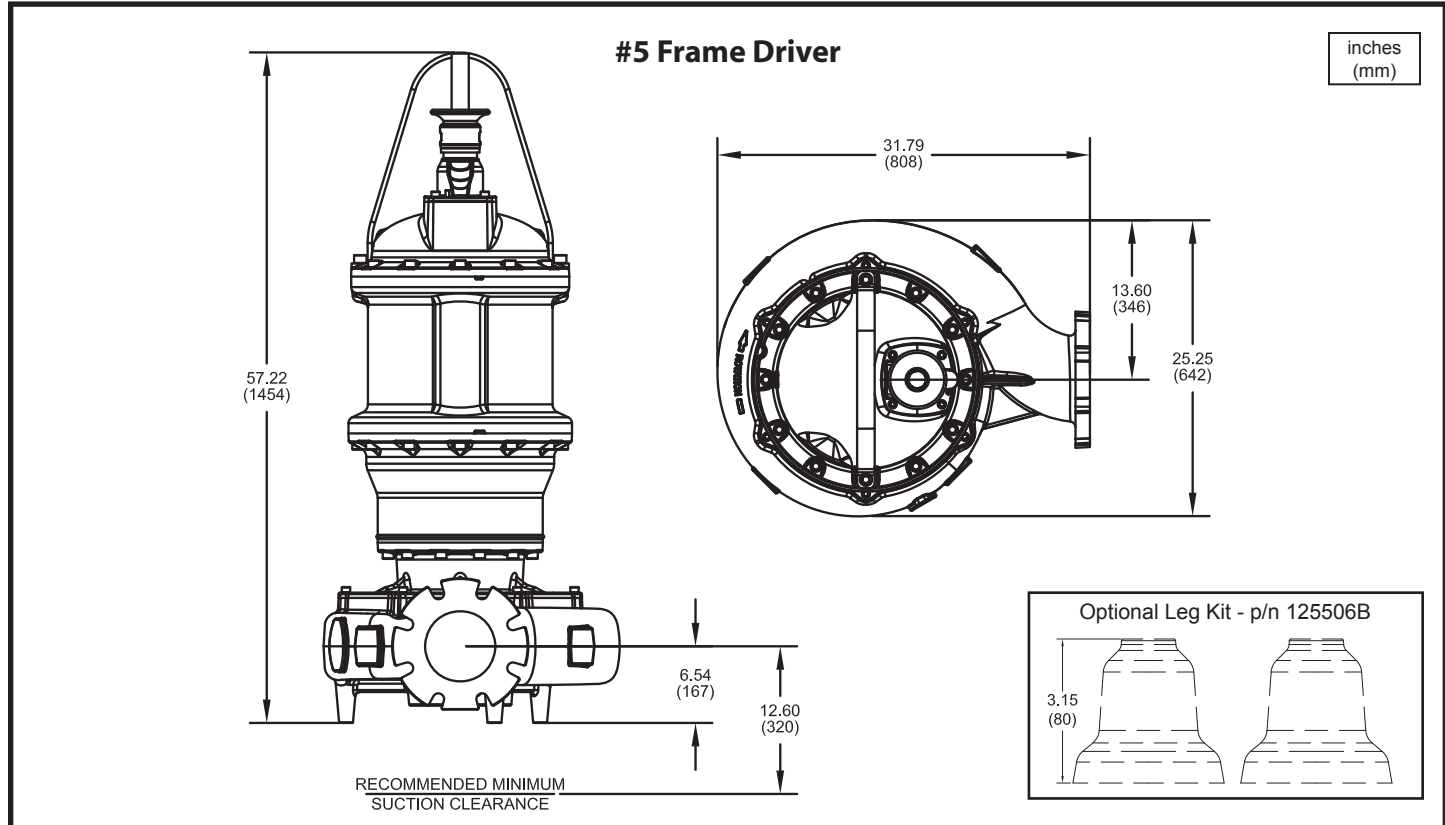

Model No.	Imp. Dia. inches (mm)	HP	Volt	PH	Hz	RPM	NEMA Start Code	Full Load Amps	S.F.	S.F. Amps	Locked Rotor Amps	Cord P/N ▲	Cord Size
7365*-658-95-30N	**	50	460	3	60	1150	H	76.4	1.15	84.0	400.0	138318	6/4 - 18/4
7365*-658-1E-30N	**	50	575	3	60	1150	H	61.2	1.15	67.2	320.0	138318	6/4 - 18/4
7365*-658-96-30N	**	60	460	3	60	1150	F	86.7	1.15	96.8	400.0	138319	2/4 - 18/4
7365*-658-1F-30N	**	60	575	3	60	1150	F	69.4	1.15	77.4	320.0	138318	6/4 - 18/4
7365*-658-67-30N	13.39 (340)	75	460	3	60	1150	H	109.3	1.15	119.5	612.0	138319	2/4 - 18/4
7365*-658-82-30N	13.39 (340)	75	575	3	60	1150	H	87.4	1.15	95.6	489.6	138319	2/4 - 18/4
7365*-658-68-30N	14.37 (365)	100	460	3	60	1150	E	135.0	1.0	135.0	612.0	138319	2/4 - 18/4
7365*-658-83-30N	14.37 (365)	100	575	3	60	1150	E	108.0	1.0	108.0	489.6	138319	2/4 - 18/4
7365*-659-94-30N	14.76 (375)	40	460	3	60	870	F	62.2	1.15	69.4	275.0	138318	6/4 - 18/4
7365*-659-1D-30N	14.76 (375)	40	575	3	60	870	F	49.8	1.15	55.5	220.0	138317	8/4 - 18/4
7365*-659-95-30N	15.55 (395)	50	460	3	60	870	D	74.5	1.15	84.9	275.0	138318	6/4 - 18/4
7365*-659-1E-30N	15.55 (395)	50	575	3	60	870	D	59.0	1.15	67.4	220.0	138317	8/4 - 18/4

* FOR NON-EXPLOSION PROOF (STANDARD) MODELS, USE FIGURE NUMBER 7365N.

▲ CORD SOLD SEPARATELY. CORD SUFFIX: XF - 50 FEET, XJ - 75 FEET, OR XL - 100 FEET.

IMPORTANT !

- 1.) MOISTURE AND TEMPERATURE SENSORS **MUST** BE CONNECTED TO VALIDATE THE CSA LISTING.
 - 2.) A SPECIAL MOISTURE SENSOR RELAY IS REQUIRED IN THE CONTROL PANEL FOR PROPER OPERATION OF THE MOISTURE SENSORS. CONTACT CP&S FOR INFORMATION CONCERNING MOISTURE SENSING RELAYS FOR CUSTOMER SUPPLIED CONTROL PANELS.
 - 3.) THESE PUMPS ARE CSA LISTED FOR PUMPING WATER AND WASTEWATER. **DO NOT USE TO PUMP FLAMMABLE LIQUIDS.** NOT SUITABLE FOR ENVIRONMENTS CONTAINING GASOLINE OR HEXANE.
 - 4.) INSTALLATIONS SUCH AS DECORATIVE FOUNTAINS OR WATER FEATURES PROVIDED FOR VISUAL ENJOYMENT MUST BE INSTALLED IN ACCORDANCE WITH THE NATIONAL ELECTRIC CODE ANSI/NFPA 70 AND/OR THE AUTHORITY HAVING JURISDICTION. THIS PUMP IS NOT INTENDED FOR USE IN SWIMMING POOLS, RECREATIONAL WATER PARKS, OR INSTALLATIONS IN WHICH HUMAN CONTACT WITH PUMPED MEDIA IS A COMMON OCCURRENCE.
 - 5.) A **NON-SPARKING** BREAKAWAY FITTING MUST BE USED TO VALIDATE THE EXPLOSION PROOF LISTING.
 - 6.) WINDING RESISTANCE ± 7.5%. WINDING RESISTANCE MEASURED IN OHMS @ 25°C (BETWEEN LINES) AT MOTOR LEADS.
 - 7.) PUMP RATED FOR OPERATION AT ± 10% VOLTAGE AT MOTOR.
 - 8.) ALL EXPLOSION PROOF PUMPS AND MOTORS ARE CSA EXPLOSION-PROOF TO CLASS I DIVISION 1 GROUPS C&D T4 RATING
- ** CUSTOMER TO SPECIFY IMPELLER DIAMETER WHEN ORDERING.

SECTION 42A
PAGE 78
DATE 2/18



PUMPS & SYSTEMS

A Crane Co. Company

USA: (937) 778-8947 • Canada: (905) 457-6223 • International: (937) 615-3598