

Demersible Chopper Pumps

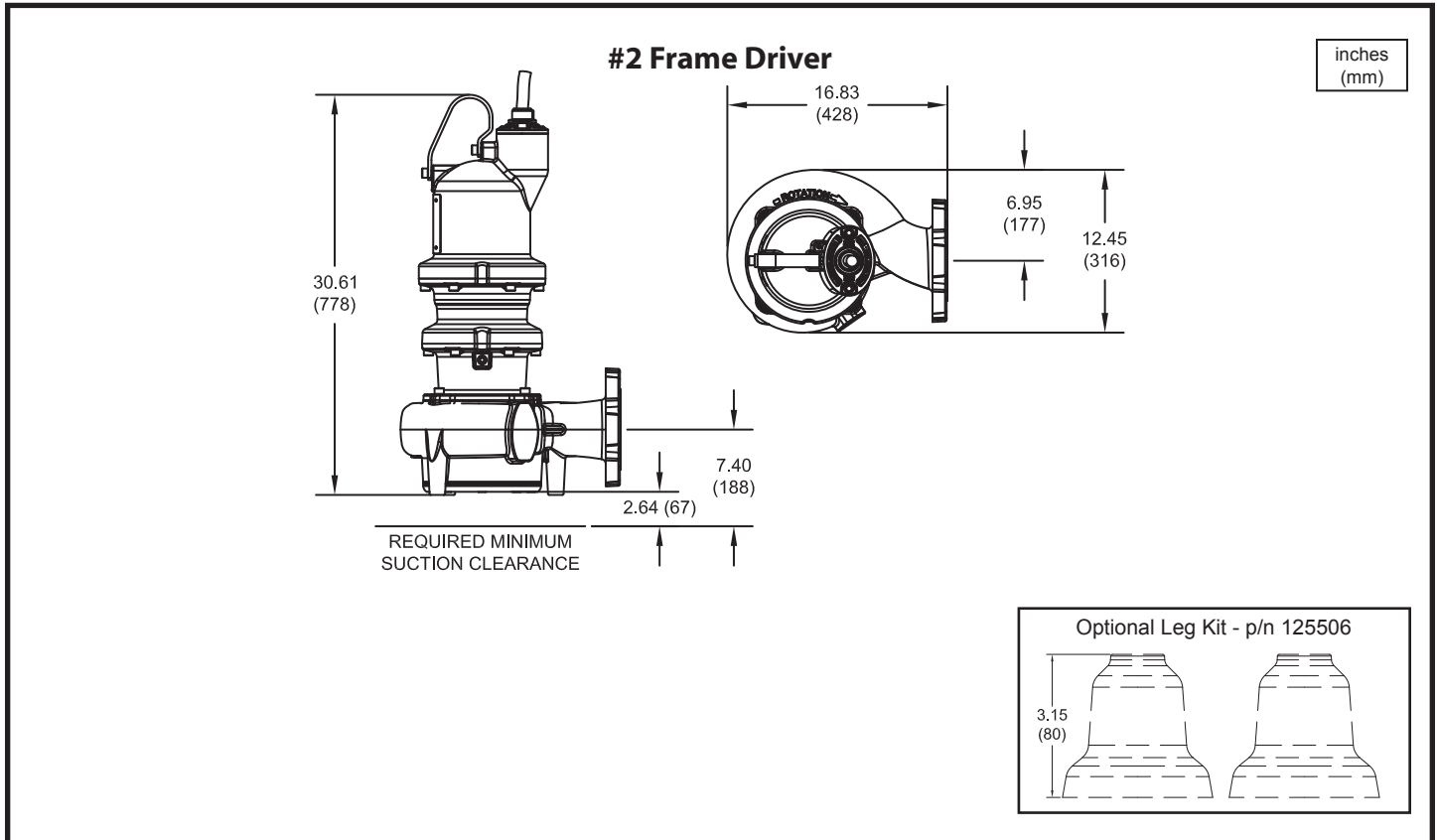

Model No.	Imp. Dia. inches (mm)	HP	Volt	PH	Hz	RPM	NEMA Start Code	Full Load Amps	S.F.	S.F. Amps	Locked Rotor Amps	Cord P/N ▲	Cord Size
7366*-424-1P-32N	6.10 (155)	3.0	208	3	60	1750	K	9.7	1.2	11.4	58.2 / 65.8	125496	12/4 - 18/4
			230					10.6		125496		12/4 - 18/4	
			460					5.3		125497		12/4 - 18/4	
7366*-424-71-32N	6.10 (155)	3.0	575	3	60	1750	N	4.5	1.2	4.9	37	125497	12/4 - 18/4
7366*-424-1R-32N	7.48 (190)	5.0	208	3	60	1750	J	15.8	1.2	18.7	82.4 / 92.4	125496	12/4 - 18/4
			230					17.2		125496		12/4 - 18/4	
			460					8.6		125497		12/4 - 18/4	
7366*-424-72-32N	7.48 (190)	5.0	575	3	60	1750	J	6	1.2	6.9	37	125497	12/4 - 18/4
7366*-424-1S-32N	7.87 (200)	7.5	208	3	60	1750	H	23.8	1.2	28.5	105.9 / 123.6	125496	12/4 - 18/4
			230					27.2		125496		12/4 - 18/4	
			460					13.6		125497		12/4 - 18/4	
7366*-424-87-32N	7.87 (200)	7.5	575	3	60	1750	H	9.5	1.2	10.9	49.4	125497	12/4 - 18/4

* FOR NON-EXPLOSION PROOF (STANDARD) MODELS, USE FIGURE NUMBER 7366N.
▲ CORD SOLD SEPARATELY.

IMPORTANT !

- 1.) MOISTURE AND TEMPERATURE SENSORS **MUST** BE CONNECTED TO VALIDATE THE CSA LISTING.
- 2.) A SPECIAL MOISTURE SENSOR RELAY IS REQUIRED IN THE CONTROL PANEL FOR PROPER OPERATION OF THE MOISTURE SENSORS. CONTACT CP&S FOR INFORMATION CONCERNING MOISTURE SENSING RELAYS FOR CUSTOMER SUPPLIED CONTROL PANELS.
- 3.) THESE PUMPS ARE CSA LISTED FOR PUMPING WATER AND WASTEWATER. **DO NOT USE TO PUMP FLAMMABLE LIQUIDS.** NOT SUITABLE FOR ENVIRONMENTS CONTAINING GASOLINE OR HEXANE.
- 4.) INSTALLATIONS SUCH AS DECORATIVE FOUNTAINS OR WATER FEATURES PROVIDED FOR VISUAL ENJOYMENT MUST BE INSTALLED IN ACCORDANCE WITH THE NATIONAL ELECTRIC CODE ANSI/NFPA 70 AND/OR THE AUTHORITY HAVING JURISDICTION. THIS PUMP IS NOT INTENDED FOR USE IN SWIMMING POOLS, RECREATIONAL WATER PARKS, OR INSTALLATIONS IN WHICH HUMAN CONTACT WITH PUMPED MEDIA IS A COMMON OCCURRENCE.
- 5.) A **NON-SPARKING** BREAKAWAY FITTING MUST BE USED TO VALIDATE THE EXPLOSION PROOF LISTING.
- 6.) WINDING RESISTANCE ± 7.5%. WINDING RESISTANCE MEASURED IN OHMS @ 25°C (BETWEEN LINES) AT MOTOR LEADS.
- 7.) PUMP RATED FOR OPERATION AT ± 10% VOLTAGE AT MOTOR.
- 8.) CORD SUFFIX: XC - 30 FEET, XF - 50 FEET, XJ - 75 FEET, OR XL - 100 FEET. CORD SOLD SEPARATELY.
- 9.) ALL EXPLOSION PROOF PUMPS AND MOTORS ARE CSA EXPLOSION-PROOF TO CLASS I DIVISION 1 GROUPS C&D T4 RATING