

## HYMAX<sup>®</sup> 2 Flip Gasket - the Next Generation Wide-range Coupling with No-tear Gasket



sizes 1.5" - 12"  
arriving 2018

### HYMAX<sup>®</sup> 2

JUST FLIP IT!

HYMAX introduces an innovative new coupling solution – the wide range HYMAX 2. HYMAX 2 coupling featuring a patented flip gasket that can easily flip in or out to accommodate different pipe ODs, allowing for faster and more efficient installations. HYMAX 2 has all other features of the original HYMAX: 2 top-facing bolts for faster and safer installation, dynamic pipe deflection that minimizes the risk of future pipe breaks due to temperature changes and ground shifts.

The original game-changing HYMAX, created by Krausz, has been field-proven in millions of installations in the USA. New and improved HYMAX 2 is a superior product.

\* This product is protected under a registered patent.



JOIN



REPAIR



RESTRAIN

## HYMAX<sup>®</sup>

Repair the past. Connect the future.

 KRAUSZ is the creator of HYMAX

Spherical Spacers -  
AISI 304 Stainless Steel

Nuts & Bolts -  
AISI 304 Stainless Steel Treated with  
Molecular Anti Galling (MAG) process

Gasket Bridge -  
AISI 304 Stainless Steel

End Rings - ASTM A283/  
A283M Grade C Steel



Flip Gasket - EPDM compounded for water  
and sewage, meets NSF-61 and NSF-372  
standards for contact with drinking water

Center Ring  
ASTM A53 Grade A Steel

Coating - 100% fusion bonded epoxy for  
enhanced corrosion protection.  
Average thickness 14 mil, meets NSF-61  
and NSF-372 standards

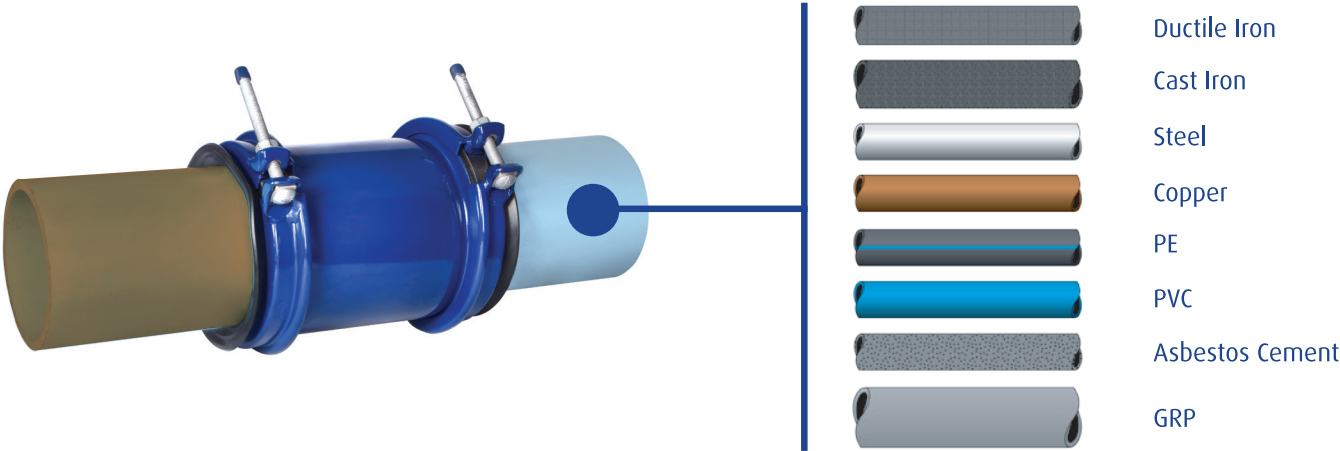



## HYMAX 2 WIDE RANGE COUPLING

Wide-range HYMAX 2 Coupling, used for section replacement, connects two pipes of the same or different OD pipe diameters and materials, up to 2.1" range.



Nominal Pipe Size  
1.5" - 12" available 2018

Krausz Part Number	ND (inch)	Overall Range (inch)	Range in Closed Gasket Position (Inch)	Range in Open Gasket Position (Inch)	Working Pressure (PSI)	Rated Pressure (PSI)
860-54-0108-16	4	4.25-5.63	4.25-5.00	4.92-5.63	260	390
860-54-0130-16	5	5.12-6.38	5.12-5.75	5.71-6.38	260	390
860-54-0163-16	6	6.42-7.68	6.42-7.05	7.01-7.68	260	390
860-54-0190-16	7	7.48-8.74	7.48-8.11	8.07-8.74	260	390
860-54-0217-16	8	8.54-9.84	8.54-9.17	9.13-9.84	260	390
860-54-0272-16	10	10.70-12.00	10.70-11.37	11.33-12.00	260	390
860-54-0278-16	10	10.96-12.26	10.96-11.63	11.59-12.26	260	390
860-54-0315-16	12	12.40-13.66	12.40-13.03	12.99-13.66	260	390
860-54-0334-16	12	13.15-14.41	13.15-13.78	13.74-14.41	260	390

## HYMAX 2 WIDE RANGE COUPLING

The product gasket is EPDM compounded for water and sewage, meets NSF-61 and NSF-372 standards for contact with drinking water.

## HYMAX 2 FLANGE ADAPTOR and FLANGE ADAPTOR LONG BODY

Wide-range HYMAX 2 Flange Adaptor connects any flanged device, such as valves, pumps and other devices, with a variety of pipe diameters and materials, up to 2.1" range.



Nominal Pipe Size  
1.5" - 12" available 2018

Krausz Part Number	ND (inch)	Flange (inch)	Overall Range (inch)	Range in Closed Gasket Position (Inch)	Range in Open Gasket Position (Inch)	Working Pressure (PSI)	Rated Pressure (PSI)
874-54-04010812	4	4	4.25-5.63	4.25-5.00	4.92-5.63	175	262
874-54-04016312	6	4	6.42-7.68	6.42-7.05	7.01-7.68	175	262
874-54-05013012	5	5	5.12-6.38	5.12-5.75	5.71-6.38	175	262
874-54-06010812	4	6	4.25-5.63	4.25-5.00	4.92-5.63	175	262
874-54-06013012	5	6	5.12-6.38	5.12-5.75	5.71-6.38	175	262
874-54-06016312	6	6	6.42-7.68	6.42-7.05	7.01-7.68	175	262
874-54-06021712	8	6	8.54-9.84	8.54-9.17	9.13-9.84	175	262
874-54-08019012	7	8	7.48-8.74	7.48-8.11	8.07-8.74	175	262
874-54-08021712	8	8	8.54-9.84	8.54-9.17	9.13-9.84	175	262
874-54-08027812	10	8	10.96-12.26	10.96-11.63	11.59-12.26	175	262
874-54-08031512	12	8	12.40-13.66	12.40-13.03	12.99-13.66	175	262
874-54-08033412	12	8	13.15-14.41	13.15-13.78	13.74-14.41	175	262
874-54-10027212	10	10	10.70-12.00	10.70-11.37	11.33-12.00	175	262
874-54-10027812	10	10	10.96-12.26	10.96-11.63	11.59-12.26	175	262
874-54-12031512	12	12	12.40-13.66	12.40-13.03	12.99-13.66	175	262
874-54-12033412	12	12	13.15-14.41	13.15-13.78	13.74-14.41	175	262
874-54-14033412	12	14	13.15-14.41	13.15-13.78	13.74-14.41	175	262

### HYMAX 2 FLANGE ADAPTOR

The product gasket is EPDM compounded for water and sewage, meets NSF-61 and NSF-372 standards for contact with drinking water.

Krausz Part Number	ND (inch)	Flange (inch)	Overall Range (inch)	Range in Closed Gasket Position (Inch)	Range in Open Gasket Position (Inch)	Working Pressure (PSI)	Rated Pressure (PSI)
974-54-04010812	4	4	4.25 - 5.63	4.25 - 5.00	4.92 - 5.63	175	262
974-54-05013012	5	5	5.12 - 6.38	5.12 - 5.75	5.71 - 6.38	175	262
974-54-06013012	5	6	5.12 - 6.38	5.12 - 5.75	5.71 - 6.38	175	262
974-54-06016312	6	6	6.42 - 7.68	6.42 - 7.05	7.01 - 7.68	175	262
974-54-08019012	7	8	7.48 - 8.74	7.48 - 8.11	8.07 - 8.74	175	262
974-54-08021712	8	8	8.54 - 9.84	8.54 - 9.17	9.13 - 9.84	175	262
974-54-10027212	10	10	10.70 - 12.00	10.70 - 11.37	11.33 - 12.00	175	262
974-54-10027812	10	10	10.96 - 12.26	10.96 - 11.63	11.59 - 12.26	175	262
974-54-12031512	12	12	12.40 - 13.66	12.40 - 13.03	12.99 - 13.66	175	262
974-54-12033412	12	12	13.15 - 14.41	13.15 - 13.78	13.74 - 14.41	175	262

### HYMAX 2 FLANGE ADAPTOR LONG BODY

The product gasket is EPDM compounded for water and sewage, meets NSF-61 and NSF-372 standards for contact with drinking water.

## HYMAX 2 LONG BODY

Wide-range HYMAX 2 Long Body Coupling, used for pipe section replacement, connects two pipes of the same or different OD pipe and materials, covering a wider gap between the pipes, with up to up to 2.1" range.

Long couplings are typically used when there is uncertainty regarding the gap between the pipes.



**Nominal Pipe Size**  
1.5" - 12" available 2018

Krausz Part Number	ND (inch)	Overall Range (inch)	Range in Closed Gasket Position (Inch)	Range in Open Gasket Position (Inch)	Working Pressure (PSI)	Rated Pressure (PSI)
862-54-0108-16	4	4.25 - 5.63	4.25 - 5.00	4.92 - 5.63	260	390
862-54-0130-16	5	5.12 - 6.38	5.12 - 5.75	5.71 - 6.38	260	390
862-54-0163-16	6	6.42 - 7.68	6.42 - 7.05	7.01 - 7.68	260	390
862-54-0190-16	7	7.48 - 8.74	7.48 - 8.11	8.07 - 8.74	260	390
862-54-0217-16	8	8.54 - 9.84	8.54 - 9.17	9.13 - 9.84	260	390
862-54-0272-16	10	10.70 - 12.00	10.70 - 11.37	11.33 - 12.00	260	390
862-54-0278-16	10	10.96 - 12.26	10.96 - 11.63	11.59 - 12.26	260	390
862-54-0315-16	12	12.40 - 13.66	12.40 - 13.03	12.99 - 13.66	260	390
862-54-0334-16	12	13.15 - 14.41	13.15 - 13.78	13.74 - 14.41	260	390

## HYMAX 2 LONG BODY

The product gasket is EPDM compounded for water and sewage, meets NSF-61 and NSF-372 standards for contact with drinking water.

## HYMAX 2 REDUCER

Wide-range HYMAX 2 Reducer joins pipes different nominal sizes and materials. Each side has a tolerance of up to 2.1", joining pipes made of a variety of materials.



Nominal Pipe Size  
1.5" - 12" available 2018

Krausz Part Number	ND (inch)	Overall Range (inch)	Range in Closed Gasket Position (inch)	Range in Open Gasket Position (inch)	Overall Range 2 (inch)	Range in Closed Gasket Position 2 (inch)	Range in Open Gasket Position 2 (inch)	Working Pressure (PSI)	Rated Pressure (PSI)
861540108013016	4 x 5	4.25-5.63	4.25-5.00	4.92-5.63	5.12-6.38	5.12-5.75	5.71-6.38	260	390
861540108016316	4 x 6	4.25-5.63	4.25-5.00	4.92-5.63	6.42-7.68	6.42-7.05	7.01-7.68	260	390
861540130016316	5 x 6	5.12-6.38	5.12-5.75	5.71-6.38	6.42-7.68	6.42-7.05	7.01-7.68	260	390
861540163019016	6 x 7	6.42-7.68	6.42-7.05	7.01-7.68	7.48-8.74	7.48-8.11	8.07-8.74	260	390
861540163021716	6 x 8	6.42-7.68	6.42-7.05	7.01-7.68	8.54-9.84	8.54-9.17	9.13-9.84	260	390
861540190021716	7 x 8	7.48-8.74	7.48-8.11	8.07-8.74	8.54-9.84	8.54-9.17	9.13-9.84	260	390
861540217027216	8 x 10	8.54-9.84	8.54-9.17	9.13-9.84	10.70-12.00	10.70-11.37	11.33-12.00	260	390
861540217031516	8 x 12	8.54-9.84	8.54-9.17	9.13-9.84	12.40-13.66	12.40-13.03	12.99-13.66	260	390
861540272027816	10 x 10	10.70-12.00	10.70-11.37	11.33-12.00	10.96-12.26	10.96-11.63	11.59-12.26	260	390
861540272031516	10 x 12	10.70-12.00	10.70-11.37	11.33-12.00	12.40-13.66	12.40-13.03	12.99-13.66	260	390
861540278031516	10 x 12	10.96-12.26	10.96-11.63	11.59-12.26	12.40-13.66	12.40-13.03	12.99-13.66	260	390
861540278033416	10 x 12	10.96-12.26	10.96-11.63	11.59-12.26	13.15-14.41	13.15-13.78	13.74-14.41	260	390
861540315033416	12 x 12	12.40-13.66	12.40-13.03	12.99-13.66	13.15-14.41	13.15-13.78	13.74-14.41	260	390

## HYMAX 2 REDUCER

The product gasket is EPDM compounded for water and sewage, meets NSF-61 and NSF-372 standards for contact with drinking water.

## HYMAX 2 THREADED OUTLET

HYMAX 2 Threaded Outlet provides effective outlet solutions for a wide variety of piping types and diameters, joining pipes made of the same or different materials, and with varying diameters of up to 2.1".



Nominal Pipe Size  
1.5" - 12" available 2018

Krausz Part Number	ND (inch)	Overall Range (inch)	Range in Closed Gasket Position (Inch)	Range in Open Gasket Position (Inch)	Working Pressure (PSI)	Rated Pressure (PSI)
865-54-XX108-16	4	4.25-5.63	4.25-5.00	4.92-5.63	260	390
865-54-XX163-16	6	6.42-7.68	6.42-7.05	7.01-7.68	260	390
865-54-XX217-16	8	8.54-9.84	8.54-9.17	9.13-9.84	260	390
865-54-XX272-16	10	10.70-12.00	10.70-11.37	11.33-12.00	260	390
865-54-XX278-16	10	10.96-12.26	10.96-11.63	11.59-12.26	260	390
865-54-XX315-16	12	12.40-13.66	12.40-13.03	12.99-13.66	260	390
865-54-XX334-16	12	13.15-14.41	13.15-13.78	13.74-14.41	260	390

## HYMAX 2 THREADED OUTLET

The product gasket is EPDM compounded for water and sewage, meets NSF-61 and NSF-372 standards for contact with drinking water.

For example 865-54-XX163-16 may be:

Krausz Part Number	ND (inch)	Outlet (inch)	Outlet L1 (inch)
865-54-01163-16	6	1	2.38
865-54-05163-16	6	1.5	3.12
865-54-02163-16	6	2	3.38
865-54-03163-16	6	3	4.25
865-54-04163-16	6	4	4.75



## HYMAX 2 FLANGE OUTLET

HYMAX 2 Flange Outlet provides effective outlet solutions for a wide variety of piping types and diameters, joining pipes made of the same or different materials, and with varying diameters of up to 2.1”.

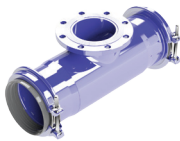

Nominal Pipe Size  
4"-12" Made To Order



## HYMAX 2 ELBOWS

Wide-range HYMAX 2 Elbows join two pipes of the same or different diameters and materials, available in 45° and 90° angles.



Nominal Pipe Size  
2" - 12" available 2018

### HYMAX 2 45° Elbow

Krausz Part Number	ND (inch)	Overall Range (inch)	Range in Closed Gasket Position (Inch)	Range in Open Gasket Position (Inch)	Working Pressure (PSI)	Rated Pressure (PSI)
869-54-45108-16	4	4.25-5.63	4.25-5.00	4.92-5.63	260	390
869-54-45130-16	5	5.12-6.38	5.12-5.75	5.71-6.38	260	390
869-54-45163-16	6	6.42-7.68	6.42-7.05	7.01-7.68	260	390
869-54-45190-16	7	7.48-8.74	7.48-8.11	8.07-8.74	260	390
869-54-45217-16	8	8.54-9.84	8.54-9.17	9.13-9.84	260	390
869-54-45272-16	10	10.70-12.00	10.70-11.37	11.33-12.00	260	390
869-54-45278-16	10	10.96-12.26	10.96-11.63	11.59-12.26	260	390
869-54-45315-16	12	12.40-13.66	12.40-13.03	12.99-13.66	260	390
869-54-45334-16	12	13.15-14.41	13.15-13.78	13.74-14.41	260	390

### HYMAX 2 45° ELBOW

The product gasket is EPDM compounded for water and sewage, meets NSF-61 and NSF-372 standards for contact with drinking water.

### HYMAX 2 90° Elbow

Krausz Part Number	ND (inch)	Overall Range (inch)	Range in Closed Gasket Position (Inch)	Range in Open Gasket Position (Inch)	Working Pressure (PSI)	Rated Pressure (PSI)
869-54-90108-16	4	4.25-5.63	4.25-5.00	4.92-5.63	260	390
869-54-90130-16	5	5.12-6.38	5.12-5.75	5.71-6.38	260	390
869-54-90163-16	6	6.42-7.68	6.42-7.05	7.01-7.68	260	390
869-54-90190-16	7	7.48-8.74	7.48-8.11	8.07-8.74	260	390
869-54-90217-16	8	8.54-9.84	8.54-9.17	9.13-9.84	260	390
869-54-90272-16	10	10.70-12.00	10.70-11.37	11.33-12.00	260	390
869-54-90278-16	10	10.96-12.26	10.96-11.63	11.59-12.26	260	390
869-54-90315-16	12	12.40-13.66	12.40-13.03	12.99-13.66	260	390
869-54-90334-16	12	13.15-14.41	13.15-13.78	13.74-14.41	260	390

### HYMAX 2 90° ELBOW

The product gasket is EPDM compounded for water and sewage, meets NSF-61 and NSF-372 standards for contact with drinking water.

## HYMAX 2 CATHODIC

Wide-range HYMAX 2 Coupling with cathodic anti-corrosion protection feature connects two pipes of the same or different diameters and materials.



Nominal Pipe Size  
1.5" - 12" available 2018

Krausz Part Number	ND (inch)	Overall Range (inch)	Range in Closed Gasket Position (Inch)	Range in Open Gasket Position (Inch)	Working Pressure (PSI)	Rated Pressure (PSI)
888-54-0108-16C 888-54-0108-16	4	4.25 - 5.63	4.25 - 5.00	4.92 - 5.63	260	390
888-54-0130-16	5	5.12 - 6.38	5.12 - 5.75	5.71 - 6.38	260	390
888-54-0163-16	6	6.42 - 7.68	6.42 - 7.05	7.01 - 7.68	260	390
888-54-0190-16	7	7.48 - 8.74	7.48 - 8.11	8.07 - 8.74	260	390
888-54-0217-16	8	8.54 - 9.84	8.54 - 9.17	9.13 - 9.84	260	390
888-54-0272-16	10	10.70 - 12.00	10.70 - 11.37	11.33 - 12.00	260	390
888-54-0278-16	10	10.96 - 12.26	10.96 - 11.63	11.59 - 12.26	260	390
888-54-0315-16	12	12.40 - 13.66	12.40 - 13.03	12.99 - 13.66	260	390
888-54-0334-16	12	13.15 - 14.41	13.15 - 13.78	13.74 - 14.41	260	390

## HYMAX 2 CATHODIC

The product gasket is EPDM compounded for water and sewage, meets NSF-61 and NSF-372 standards for contact with drinking water.

## HYMAX<sup>2</sup> Features

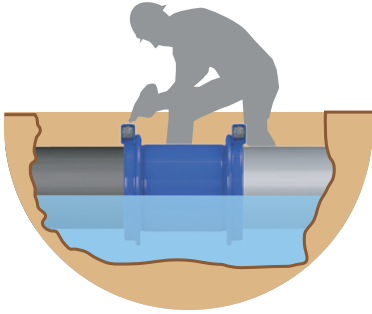

### Fast and easy installation

- Lightweight construction enables fast and easy installation, with minimum manpower, reducing time in the ditch and improving worker safety.
- Unique top-facing bolts enable easy installation access.
- Ready-to-use, stab-on design eliminates the need for extensive under-pipe digging and work.



### Multiple applications

- All products accommodate a variety of pipe materials: ductile iron, cast iron, steel, copper, PE, PVC, AC and GRP.
- One single product can connect pipes of two different materials, allowing transition capability of up to 1.3".

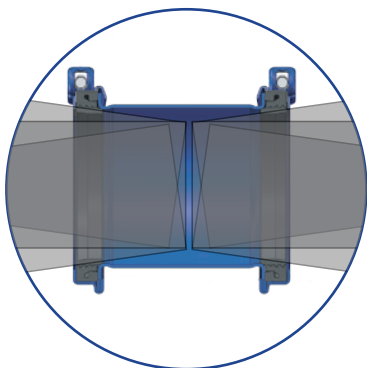

### Flexible connection

- Allows for up to 4° angular deflection on each end, during installation as well as for misaligned pipes.
- Absorbs post-installation dynamic pipe deflection of up to 4° on each end, reducing the risk of damage and cracking due to ground shifts and temperature changes.
- Adapts to out-of-round pipe shape (up to 0.31"), for optimum fit on both ends.



## High durability

- High-quality sealing solution – patented hydraulically-assisted gasket features two-stage sealing: mechanical sealing that is effective under vacuum or non-pressure; and self-inflated gasket using water pressure.
- Fusion-bonded epoxy coating enables an insulated product and prevents corrosion.
- Nuts, bolts and other components are made of stainless steel.
- Innovative radial closing design and sealing systems eliminate installation errors.
- Advanced Molecular Anti-Galling (MAG) unique dry treatment process on nuts and bolts, based on embedded zinc, prevents galling and enables repeated bolt tightening; it also eliminates the need for grease, preventing dust and dirt build-up.
- One-piece design delivers fortified strength and enhanced flexibility.

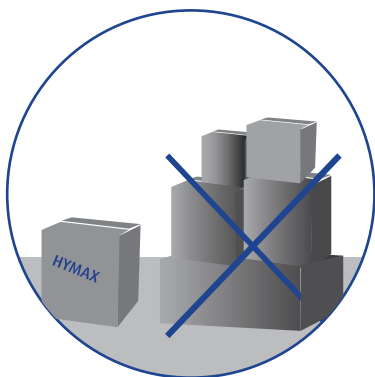

## Cost-saving

- HYMAX 2 products suit a wide range of pipe diameters, replacing the need to use dedicated products and thus reducing inventory costs and saving shelf space.
- Fast and easy installation saves time and money.



## HYMAX<sup>®</sup> 2 Product information

1. HYMAX 2 meets or exceeds all specifications of AWWA Standard C219, NSF-61 and NSF-372.
2. Center Ring: ASTM A53 Grade A Steel.
3. End ring: ASTM A283/A283M Grade C Steel.
4. Gaskets: EPDM compounded for water and sewage, meet NSF-61 and NSF-372 standards for contact with drinking water.
5. Nuts and bolts: AISI 304 Stainless Steel. Rolled thread and Molecular Anti Galling (MAG) treatment.
6. Bridge: AISI 304 Stainless Steel.
7. Coating: 100% fusion bonded epoxy for enhanced corrosion protection. Average thickness 14 mil, meets NSF-61 and NSF-372 standards.
8. Deflection up to 4° per side.
9. Working temperature:  
EPDM: -20°F up to +125°F.
10. Working pressure: 260 psi

\* Data may vary according to product type and size. For product specification sheet please Call your Krausz dealer.



Flip Gasket allows  
adjusting to pipe diameter

# 90 YEARS OF INNOVATIVE PIPE JOIN AND REPAIR SOLUTIONS



For 90 years, Krausz, the creator of HYMAX, has developed and manufactured market-leading products for the repair and connection of different pipe types in the potable water and sewage markets. We have a solid reputation selling a wide variety of innovative, easy-to-use, durable products that save time and reduce inventory.





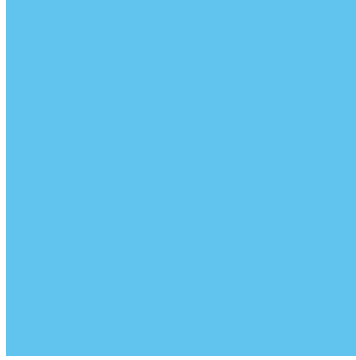

**KRAUSZ USA**  
**331 SW 57TH AVENUE, OCALA,**  
**FLORIDA 34474**  
**TEL: 855-457-2879 OR 855-4KRAUSZ**  
**FAX: 352-304-5787**

[INFO@KRAUSZUSA.COM](mailto:INFO@KRAUSZUSA.COM)  
[WWW.KRAUSZUSA.COM](http://WWW.KRAUSZUSA.COM)

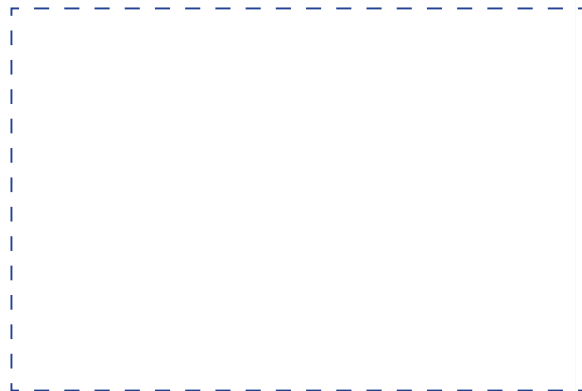

JOIN



REPAIR



RESTRAIN

**KRAUSZ** is the creator of **HYMAX**